

# RADIO NEWS

N.S.F.

FEBRUARY  
1941  
25c  
In Canada 30c

Radio Commands  
from the Air



**Uncle Sam Wants Civilian Radiomen**

ADVANCED BEGINNER'S SUPERHETERODYNE

Servicing **F. M. Receivers**



**De Luxe Freq. Standard**

*de Forest on Color Television*

**DAVEGA AMATEUR RADIO—63 CORTLANDT ST., N.Y., N.Y.**  
**(DIVISION OF DAVEGA CITY RADIO—WORLD'S LARGEST RADIO DEALER)**

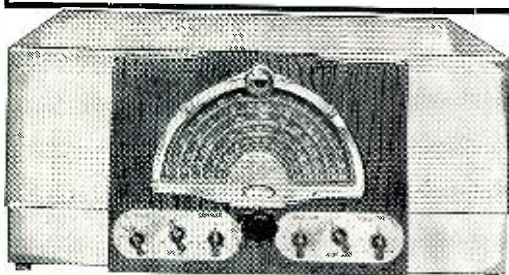

**FINEST McMURDO CHASSIS EVER BUILT!**

Two R.F. Stages  
 Variable Selectivity  
 Giant Jensen 18" Speaker  
 Finest Shielding  
 34 Watts Undistorted

Built to  
 Sell for  
 \$350.00

**189<sup>50</sup>**

Complete including 18" Speaker made by Jensen

**Made by Radio Headquarters RCA**

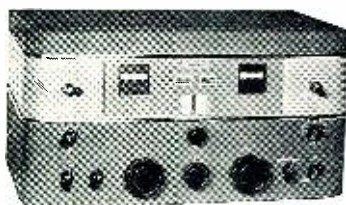

**AR 77 WITH DUAL  
 R.F. ALIGNMENT**

**139.50**

IMPROVED  
 IMAGE  
 REJECTION  
 ANTENNA  
 TRIMMER

**HALLICRAFTER SUPER SKY RIDER**

6 BANDS • 15 TUBES  
 VARIABLE SELECTIVITY  
 2 R.F. STAGES  
 HI-FI-AUDIO SYSTEM  
 FOR FINE TONE

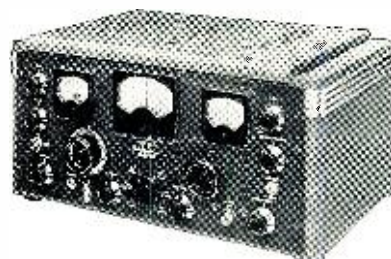

**159.50**

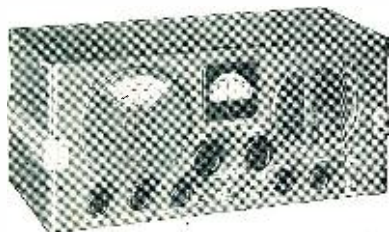

**Hallicrafter  
 S.20R**

R.F. stage, 2 I. F. stages,  
 9 tubes, noise limiter,  
 bandspread.

**49.50**

**Hallicrafter  
 SX23**

THE SET THAT HAS  
 EVERYTHING. WRITE  
 FOR OUR SPECIAL  
 PRICE.

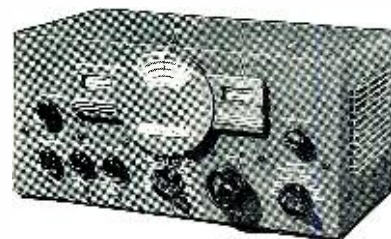

**Federal Recorder  
 Model P 12**

Professional 12" recorder, 15  
 watt audio public address, 25.00  
 mike and stand. Perfect record-  
 ings.

List Price  
 over  
 \$200.00 **79.50**

**HALLICRAFTER DUAL DIVERSITY**

25 Tubes  
 2-8 Gang  
 Condensers

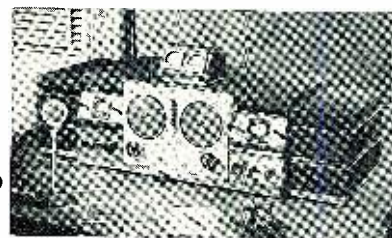

SPECIALLY PRICED  
**395.00**

FINEST CONSTRUCTION

**NEW HALLICRAFTER UNIVERSAL  
 S-29 SKY TRAVELER 553-9.85  
 METERS**

AC-DC battery operation, self  
 charging unit built in. Self-con-  
 tained antenna, elec-  
 trical bandspread. **59.50**



LARGEST STOCK OF  
 MICROPHONES at the  
 lowest prices. Let us  
 quote you.

**DISTRIBUTORS FOR**

- Hallicrafters
  - National
  - Sargent
  - RCA
  - Hammarlund
  - Howard
  - RME
- and other famous makes

**Sargent WAC44**

Regular  
 Price  
 \$139.50 **94.50**

Two stages, pre-selec-  
 tion, frequency monitor,  
 permanent alignment  
 from panel.

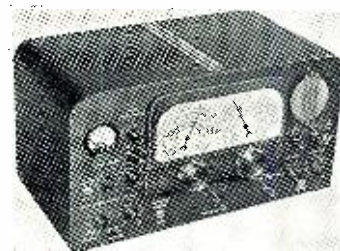

**DAVEGA**

**AMATEUR DIVISION—63 CORTLANDT ST., N. Y., N. Y.**

**★ World's Largest Radio Dealer . . . Established 1879**



**J. E. SMITH, President**  
**NATIONAL RADIO INSTITUTE**  
Established 25 Years

He has directed the training of more men for the Radio industry than anyone else.

# I will send you a Lesson Free to show how I train you at home in spare time for Good Jobs in Radio



Broadcasting Stations employ operators, installation, maintenance men and Radio Technicians in other capacities and pay well.



Set Servicing pays many Radio Technicians \$30, \$40, \$50 a week, others hold their regular jobs and make \$5 to \$10 extra a week in spare time.

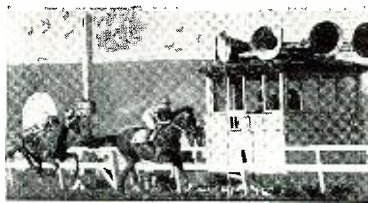

Loudspeaker System building, installing, servicing and operating is another growing field for well trained Radio Technicians.

## I Trained These Men



**Chief Operator Broadcasting Station**

Before I completed all the lessons, I obtained my Radio Broadcast Operator's license and immediately joined Station WMPC where I am now Chief Operator. **HOLLIS F. HAYES**, 327 Madison St., Lapeer, Mich.

\$10 to \$20 a Week in Spare Time I repaired some radio sets when I was on my tenth lesson. I really don't see how you can give so much for such a small amount of money. I made \$600 in a year and a half, and I have made an average of \$10 to \$20 a week—just spare time. **JOHN JERRY**, 1529 Arapahoe St., Rm. 17, Denver, Colorado.



**Former Truck Driver Has Own Radio Shop**

Before taking your Course I earned about 17½ cents an hour as a truck driver. When I had completed 20 lessons I started service work. During the last two years I have made about \$3,000 in Radio. I now own my own shop. **KARL KELLY**, 409 W. Cathoun St., Magnolia, Ark.

Get my sample lesson Free. Examine it, read it—see how clear it is, how easy to understand. Find out how I train you at home in spare time to be a Radio Technician. Do it now. Mail the coupon.

### Jobs Like These Go to Men Who Know Radio

Radio Broadcasting stations employ Radio Technicians as operators, maintenance men and pay well for trained men. Radio manufacturers employ testers, inspectors, servicemen in good pay jobs with opportunities for advancement. Radio jobbers and dealers employ installation and servicemen. Many Radio Technicians open their own Radio sales and repair businesses and make \$30, \$40, \$50 a week. Others hold their regular jobs and make \$5 to \$10 a week fixing Radios in spare time. Automobile, police, aviation, commercial Radio, loudspeaker systems, electronic devices, are newer fields of opportunities for which N. R. I. gives the required knowledge of Radio. And my Course includes Television, which promises to open good jobs soon.

### Why Many Radio Technicians Make \$30, \$40, \$50 a Week

Radio is already one of the country's large industries even though it is still young and growing. The arrival of Television, the use of Radio principles in industry, are but a few of many recent Radio developments. More than 28,000,000 homes have one or more Radios. There are more Radios than telephones. Every year millions of Radios go out of date and are replaced. Millions more need new tubes, repairs, etc. Over 5,000,000 auto Radios are in use and thousands more are being sold every day. In every branch, Radio offers opportunities for which I give you the required knowledge of Radio at home in your spare time. Yes, the few hundred \$30, \$40, \$50 a week jobs of 20 years ago have grown to thousands.

### Many Make \$5 to \$10 a Week Extra in Spare Time While Learning

The day you enroll, in addition to my regular Course, I start sending you Extra Money Job Sheets—start showing you how to do actual

Radio repair jobs. Throughout your course I send plans and directions which have helped many make \$5 to \$10 a week in spare time while learning. I send special Radio equipment; show you how to conduct experiments, build circuits. My Course includes Television, too.

### You Get This Professional Servicing Instrument

This instrument makes practically any test you will be called upon to make in Radio service work on both spare time and full time jobs. It can be used on the test bench, or carried along when out on calls. It measures A.C. and D.C. voltages and currents; tests resistances; has a multi-band oscillator for aligning



any set, old or new. You get this instrument to keep as part of your N. R. I. Course.

### Find Out How N. R. I. Teaches Radio and Television

Act today. Mail coupon now for Sample Lesson and 64-page Book. They're FREE. They point out Radio's spare time and full time opportunities and those coming in Television; tell about my course in Radio and Television; show more than 100 letters from men I trained, telling what they are doing and earning. Read my money back agreement. Find out what Radio offers you. Mail coupon in an envelope or paste on penny postcard—NOW.

J. E. SMITH, President  
Dept. 1BR  
National Radio Institute  
Washington, D. C.

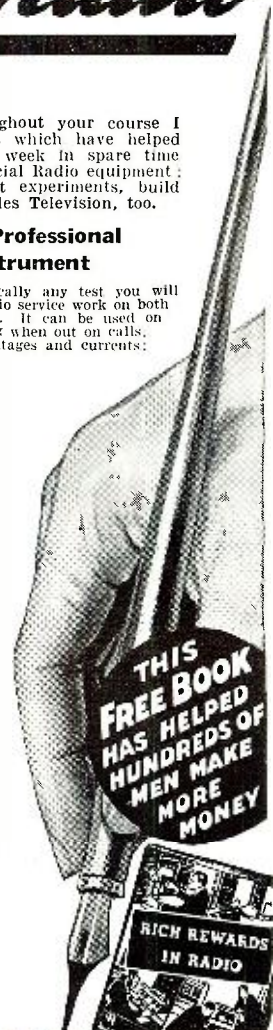

## SAMPLE LESSON FREE

I want to prove our Course gives practical, money-making information; that it is easy to understand—what you need to master Radio. My Sample Lesson text, "Radio Receiver Troubles—Their Cause and Remedy," covers a long list of Radio receiver troubles in A.C., D.C., battery in universal, auto, T.R.F., superheterodyne, all-wave, and other types of sets. And a cross reference system gives you the probable cause and a quick way to locate and remedy these set troubles. A special section is devoted to receiver check-up, alignment, balancing, neutralizing, testing.

## Good for Both 64 PAGE BOOK SAMPLE LESSON Free

J. E. SMITH, President, Dept. 1BR  
National Radio Institute, Washington, D. C.

Without obligating me, mail your Sample Lesson and 64-page Book FREE. I am particularly interested in the branch of Radio checked below. (No salesman will call. Write plainly.)

- |   |   |
|---|---|
| <input type="checkbox"/> Radio Service Business of My Own     | <input type="checkbox"/> Loudspeaker Systems, Installations and Service |
| <input type="checkbox"/> Service Technician for Retail Stores | <input type="checkbox"/> Auto Radio Installations and Service           |
| <input type="checkbox"/> Spare Time Radio Repair Work         | <input type="checkbox"/> Television                                     |
| <input type="checkbox"/> Broadcasting Station Operator        | <input type="checkbox"/> All-around Servicing Technician                |

(If you have not decided which branch you prefer—mail coupon now, for information to help you decide.)

Name..... Age.....  
Address.....  
City..... State..... 14X1



BY THE EDITOR

AS a rule, and as part of the so-called "Writer's Curse," the editor of a radio publication such as this sometimes finds himself facing a blank sheet of paper when it comes to the time that he must write his column. This month is so exceptional with its wealth of news, that we thought we'd mention it. We honestly discarded almost twice as much material for the *Washington Column* as we have run. Radio news is so fast in the making this month, and so much is happening in Washington, which is of vital interest to amateurs and to the industry as well, that we hardly know where to start.

\* \* \*

PROBABLY the most outstanding piece of news furnished us by our *Washington Correspondent* is the alleged concerted effort by the *American Radio Relay League* to obtain more amateurs by lowering the admission requirements for the license. In this move we heartily concur. We know that the amateur has made an enviable record as a public servant; and we believe he will make an enviable record should he be called upon for any national emergency. The sole question remaining was whether there would be enough amateurs, and we believe this to be the right idea—getting as many of our young people to become interested in radio as is possible. Only in this way will there be an almost inexhaustible supply of radiomen available in a national emergency, and only in this way will Uncle Sam have enough radiomen to meet all of his requirements.

\* \* \*

WE were truly amazed at the response to our advertisement offering to sell the laboratory model of the little tuner we ran last month. With the tuner market obviously bullish, we wonder why some manufacturer has not taken advantage of the situation to bring out such a unit priced in the neighborhood of \$12.00 to \$18.00. It is with pardonable pride that we offer our circuit to whatever manufacturer cares to avail himself of it. We hope that he will have many, many buyers. We suspect that the reason there are so many buyers interested in tuners is because of the tremendous boom in recording; and nothing makes quite as good a recorder-tuner as the old *T.R.F.* tuner.

\* \* \*

A READER writes us asking what has happened to the "Super-Super-Super Superheterodyne" which was being designed in the *R.N. Labs.* Here is a report. The "Super-Superheterodyne" has been completed, at least, on paper. It will contain 35  
(Continued on page 49)



Trade-Mark Registered

Including Articles on POPULAR TELEVISION

The Magazine for the radio amateur  
experimenter, serviceman & dealer

VOL. 25, NO. 2

Contents for February, 1941

FEATURES

- War and the English Radio Serviceman . . . Archie C. Biddlecome 6**  
Showing that you cannot bomb a serviceman out of business.
- Uncle Sam Wants Civilian Radiomen . . . Samuel Milbourne 8**  
A digest of most of the radio civilian jobs open via Civil Service.
- Color in Television . . . Dr. Lee deForest 9**  
A famous inventor explains this newest type of television.
- Advanced Beginner's Superheterodyne . . . Clark E. Jackson 10**  
A simple 6-tube receiver for the constructor.
- Testing F.M. Receivers . . . Willard Moody 13**  
A few pointers for the serviceman who gets one of the F.M. sets to repair.
- As I See It! . . . John F. Rider 14**  
A column of personal opinion of an old serviceman.
- Underground River Tracer . . . Capel W. McNash 15**  
A blind radio amateur attempts to solve a geologic mystery.
- A Calibrated ECO 80-20 Meter Xmtr . . . Karl A. Kopetzky, W9QEA 16**  
Using a BC station to set an ECO.
- Deluxe Frequency Standard . . . C. G. Sims & C. B. Lester 20**  
An FCC approved unit, originally designed for station WHOP.
- How to Build Your Own Recording Studio . . . Oliver Read, W9ETI 24**  
Part 3: Testing your recorder's frequency response.
- Communications & Electronic Maintenance, Part 3 . . . W. H. Bohlke 30**  
Adding two units to the universal service test bench.
- Leakage Tester for Electrolytic Condensers . . . Jack D. Clement 38**  
A simple way to test those questionable electrolytics.

Cover Picture: Official U.S. Air Corps picture of a radio-equipped observation plane.

DEPARTMENTS

- |  |                                       |                                       |
|--|---------------------------------------|---------------------------------------|
| Book Review . . . . . 40               | QRD? . . . . . 35                     | Aviation Radio . . . . . 22           |
| What's New in Radio . . . 27           | Bench Notes . . . . . 19              | Serviceman's Experiences . . . . . 23 |
| Radio Physics Course . . . 57          | Manufacturer's Literature 40          | Serviceman's Cases . . . . . 66       |
| Hamchatter . . . . . 33                | Cuttings . . . . . 26                 | The Video Reporter . . . . . 32       |
| Serviceman's Legal Advice . . . . . 29 | Washington Communication . . . . . 12 | Ringing the Bell . . . . . 37         |

Copyright 1941,  
ZIFF-DAVIS PUBLISHING COMPANY  
Member of the Audit Bureau of Circulations

RADIO NEWS is published monthly by the Ziff-Davis Publishing Company at 608 S. Dearborn St., Chicago, Ill., William B. Ziff, Publisher; B. G. Davis, Editor; J. Fred Henry, Business Manager; Karl A. Kopetzky, W9QEA, Managing Editor; Oliver Read, W9ETI, Technical Editor; Herman R. Ballin, Art Director; S. L. Cahn, Advertising Manager. New York Office, 381 Fourth Ave. Subscription \$2.50 per year; single copies, 25 cents; foreign postage \$1.00 per year additional, Canada 50c additional. Entered as second class matter March 9, 1938, at the Post Office, Chicago, Illinois, under the Act of March 3, 1879. Contributors should retain a copy of contributions. All submitted material must contain return postage. Contributions will be handled with reasonable care, but this magazine assumes no responsibility for their safety. Accepted material is subject to whatever adaptations, and revisions, including "by-line" changes, necessary to meet requirements. Payment will be made at our current rates upon acceptance and, unless otherwise specified by contributor, all photographs and drawings will be considered as constituting a part of the manuscript in making payment.

# Leo-W9GFQ Sells the *Quality* Line of Communications Receivers

*It's Easy  
to Pay  
Leo's Way!*

Let's get acquainted today!

*Only*  
**\$15<sup>95</sup> DOWN**  
ON  
**SX-28**



**C**HECK all these improved Hallicrafter features! 15 tubes—6 bands—Frequency range 550 kc. to 43 mc.—Two stages preselection—Electrical bandspread on ALL Bands including international short wave band—Calibrated bandspread inertia controlled—Micrometer scale tuning inertia controlled—Tone and AC—Beat Frequency Oscillator—AF Gain—RF Gain—Crystal phasing

—Adjustable noise limiter—Send-receive switch—80, 40, 20 and 10 meter amateur bands calibrated—Band pass audio filter—Push-pull high fidelity, audio output—Phone jack—Dimensions 20½" x 10" x 14¾". Model SX-28 with crystal and tubes. \$159.50.

### FREE • A SENSATIONAL OFFER • FREE

A brand new two-color map of the United States—size approx. 3½ ft. x 4½ ft.—showing RADIO DISTRICTS, TIME ZONES, MONITORING STATIONS and important CITIES—simply send 15c to cover postage and packing with NO OTHER CHARGES. The map will be sent out to you promptly. We do this in appreciation of the many friends and boosters we have throughout the country.

### \$5.95 Down on the Sensational S-29

The Sky Traveler—take it with you or use it at home. A Hallicrafter designed to communication tolerances—Frequency coverage from 542 kc. to 30.5 mc. (553 to 9.85 meters) on 4 bands. Self-contained antenna with high gain coupling circuit provides truly remarkable reception throughout its tuning range. 9 tubes. Operates on either 110 volt AC or DC or from its self-contained batteries. Dimensions 7" x 8½" x 13¼". Weight including batteries 18 lbs. Price \$59.50.

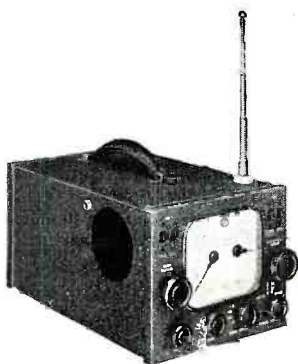

### A Year to Pay on the Sky Buddy Only \$2.08 per Month

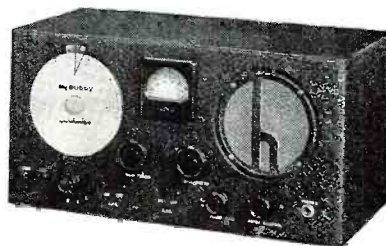

Compare the Hallicrafters Sky Buddy with communications receivers selling at anywhere near this price. Continuous 44 mc. to 545 kc., plus the 10 meter band with uniform selectivity, 6 tubes, 4 bands. Electrical bandspread. Dimensions—17½" x 8½" x 8½". Model S-19R—Price \$29.50.

#### 124 PAGES • NEW CATALOG • 124 PAGES

Write for our sensational new catalog—nothing like it before. New items, exclusive items—everything for the amateur—a real catalog.

*Write for one today*

#### WE OFFER YOU THE LOWEST 6% PLAN AVAILABLE

On any nationally known part, receiver or XMTR shown in any catalog or advertisement at the lowest price shown. FOR QUICK SERVICE—WITH NO RED TAPE—WRITE (LEO) W9GFQ.

## WHOLESALE RADIO LABORATORIES

"EVERYTHING FOR THE HAM"

W9GFQ, COUNCIL BLUFFS, IOWA



# WAR

## & English Servicemen

BY ARCHIE C. BIDDLECOME

Serviceman, London, England

EXCERPTS FROM THE  
LETTER ACCOMPANYING  
THIS ARTICLE.

... Since writing you last we here in London have, of course, passed through a hectic time but we are still getting about and doing our jobs, raids permitting. Things are not nearly so bad as they appear to be described outside the country and communications are very little affected. Only recently on my way home, bombs fell in the High Street of a certain town through which I was passing and a couple days afterwards the craters had been filled in and you would have thought that the road had merely been up for repairs.

Naturally there are always the unlucky ones. While some of "Jerry's" bombs are really big stuff [Here the censor cut out a sentence.—Ed.]. With our boys of the Air Force keeping the invaders off, as they are doing I have every reason to believe that there will still be plenty of things that I can do with your cheque for the article!

**When bombs demolish houses, and air-raids keep you below grounds, what happens to the radio serviceman and his radio sets?**

**T**HE radio trade in the British Isles has had many problems to face and these have been featured in articles which have appeared in the past issues of this journal.

One of the latest and most serious blows is that radio engineers including fault finders, service men, etc., are no longer regarded as being in a reserved occupation unless they are over 35 years old. Up to the time of writing, engineers in the radio trade who were over 30 years of age could not be taken by the fighting services. Men under that age had to respond to their calling up notices and, as already stated in the article referred to, thousands of dealers lost their key service engi-

neers and had to search the country for service men either medically unfit for fighting service or over the age of 30.

Once more, therefore, the radio trade must undergo a great re-shuffling of personnel and what exactly is going to happen to the production of radio equipment and receivers cannot at the moment be foreseen.

However, let us not dwell too deeply on the unhappy thought of what the radio industry of Great Britain may be reduced to but rather let me tell you of some of the more interesting problems we have had to face.

An important legislation which gave us all quite a large amount of work



"We get lots of sets that have been through an air-raid. Sometimes they can be easily repaired and sometimes, not."



"When your shop in a store like this has been completely gutted, you grin, and start all over."

concerned the prohibition of car radio. All vehicles including caravans, or what you, I believe, term trailers are prohibited from having any form of self-contained receiver which could be used by an occupant of the vehicle to pick up radio signals. This order covered not only standard types of car radio installations run from the car battery but also self-contained portable receivers and even ordinary battery receivers containing their own batteries but requiring an external aerial and earth. Obviously the latter type of receiver by the addition of a short length of wire to the aerial and earth terminal could quickly be made into just as an efficient receiving station as could the other types of receivers.

Quite a good deal of work came the way of some enterprising service men who advertised the fact that not only could they remove the car radio from the motor car but could also fit it up in the owner's house or in his air raid shelter as an emergency receiver. These installations were, in many cases, very interesting and the power required to operate the car radio was derived either from a spare car battery in some cases fed by an automatic trickle charger or from the mains supply to the house after voltage had been suitably reduced. Many owners of car radio receivers had them installed as a bedside fitting with the receiver and loudspeaker installed in a cupboard or

*(Continued on page 50)*

"Small shops are hardest hit because the proprietors are usually too poor to replace their test instruments. They try to build their own from salvaged parts."



# ★ UNCLE SAM WANTS CIVILIAN RADIOMEN ★

As compiled by *Samuel Milburne*  
Greenwood, Mississippi

Here is a digest of all the radio jobs which are available through the Civil Service Commission.

**E**VEN though you can't enlist or have not been drafted, you may be able to do your bit for National Defense by qualifying for a job under the Federal civil service.

The government needs thousands of skilled workers to build ships, guns, and airplanes. Good pay, satisfactory hours, and an opportunity to serve your country in a time of need are three mighty good reasons for looking into this a little further.

If you are an engineer or a machinist, or if you are experienced in the operation, installation or testing of radio equipment, you may be able to help the government and at the same time help yourself.

After studying numerous announcements of pending Federal civil-service examinations, we are of the opinion that there are thousands of radio men in the country today who could easily qualify for one or more of these jobs.

Vacancies exist in many fields, but in this article we shall state the requirements for the radio jobs only. In the outline below, the number opposite the name of the position refers to the number of the printed announcement giving detailed information regarding the examination. If you wish to request a copy of an announcement, you may call for it by number, thereby making sure that you get the right one. These "examinations" are actually questionnaires or job applica-

tions, to be filled out by you at your home and returned to the Civil Service Commission. They are called "unassembled" examinations because applicants are not required to assemble in an examination room to take them.

#### RADIO OPERATOR (No. 93)

Salary \$1,620 and \$1,800 a year.

For employment in the Civil Aeronautics Authority and in the Federal Communications Commission.

#### Duties

To stand regular watch for the transmission and reception of radio messages, and to be responsible for the operation and maintenance of the station and equipment. Teletype communication may be required in some positions.

#### Qualifications

All applicants must be able to transmit and receive radiotelegraph traffic (International Morse Code) at a sustained speed of at least 20 words a minute in plain language. In addition, they must show—in any one of several specified ways—that they are qualified with respect to length of experience and the holding of a radio operator's license. In the latter connection, the following are among the bases of qualification: (1) Possession of a valid license as radiotelegraph operator, first class; (2) possession of a valid license as radiotelegraph operator, second class, plus at least 2 years

of experience as radiotelegraph operator at a station employing radio telegraphy; (3) the holding of an amateur license for a continuous period of at least 5 years; and (4) at least 1 year of experience, within the most recent 5 years, as radiotelegraph operator on board a ship of the United States Navy, United States Coast Guard, or other Government vessel, or at a Government radio shore station employing radio telegraphy.

Names of eligibles who possess a first-class radiotelegraph operator's license, or who are qualified to handle code traffic at 25 words a minute or over, will be placed on a separate register. Only the persons on this register will be eligible for appointment to positions paying \$1,800 a year in the Federal Communications Commission.

#### INSPECTOR, ENGINEERING MATERIALS (No. 103)

#### Salary

Senior Inspector—\$2,600 a year.  
Inspector —\$2,000 a year.  
Junior Inspector—\$1,620 a year.

For employment in the Navy Department.

#### Duties

To inspect and test, for determining compliance with specifications, various types of radio engineering materials; to read drawings, interpret specifications, and to make necessary computations to determine compliance therewith; to make inspection reports and conduct correspondence. The senior inspector's duties may also require organizing and supervising a staff of inspectors. Junior inspectors will usually be required to enter upon a period of training in inspection technique and procedure.

#### Qualifications—Senior Inspector and Inspector

For Senior Inspector, 6 years, and for Inspector, 4 years, in the inspecting and/or testing of a variety of radio engineering materials. These include complete radio telegraph and radio telephone transmitting equipment; direction-finding and navigation equipment of various types; major component units and parts, etc.

The following substitutions may be made: Each year of electrical or radio engineering in a college or university of recognized standing, for 9 months of the specified experience. Each 6 months of study in practical electrical work or in radio theory and design in a resident school, for 6 months of the specified experience. Each year of experience as design engineer engaged in the design of naval radio equipment to meet definite specification require-

(Continued on page 54)

#### SOMETHING THEY DON'T TELL ABOUT!





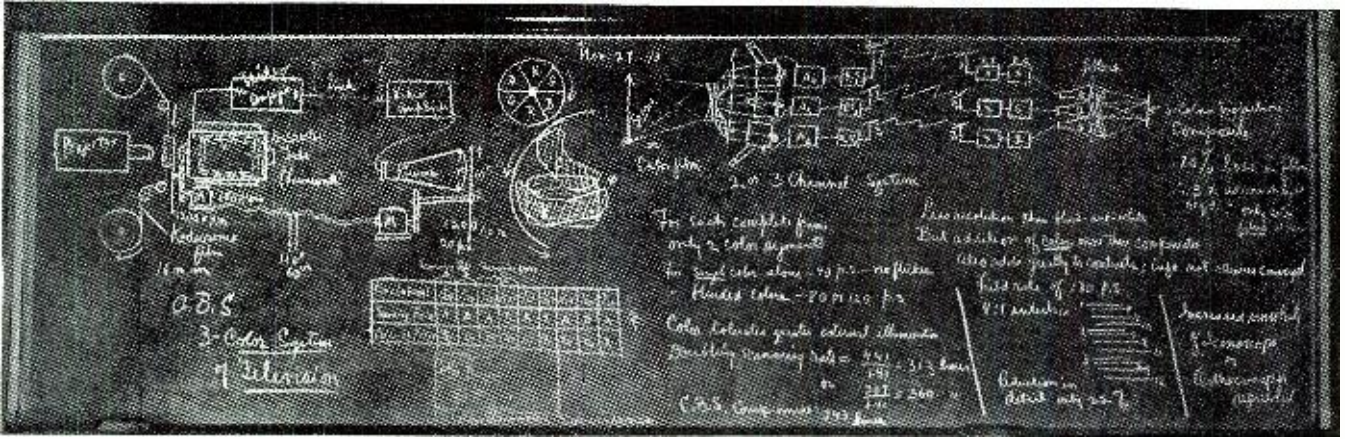

# COLOR in Television

by Dr. Lee de Forest

**How color television has been made possible; written by a famous inventor.**

COLOR television, television in three colors, is a subject that is not only interesting but specially timely. Yesterday television itself was considered an impossibility and now we are clamoring for color, and I suppose before many years we will be clamoring for three-dimensional pictures.

Color television was recently demonstrated by CBS in New York but long prior to that it was shown in England by Baird who used the mechanical scanning and reproducing systems. But the only systems that have yet been demonstrated use the old device that produced the first motion pictures in color; that is the color disk which was first introduced by *Kinemascope* away back in 1910. That color was a simple process. In front of the camera was located a two-sector color disk; one sector was a red filter, the other a green, or a combination of orange-red and green-blue was used. The photograph was taken first through one color screen and then through the other. In other words, one frame on the motion picture was taken through the red-orange filter and the next succeeding frame was photographed through the green-blue filter. When this colored film was projected they used a like color wheel in front of the projector so that one frame was projected on the screen through the red sector in the disk and the next was projected through the green sector. The images on the screen in red and green followed each other so rapidly that the impression of true color was registered in the brain of the observer. It wasn't true color reproduction but it was a fair approximation to natural colors. A combination of the right shades of red, green and blue will give very close to real colors such as you would get by using the seven colors of the spectrum. As proof of that, witness the beautiful technicolor pictures we see in theatres nowadays. Those pictures are made through three filters, the magenta red, a certain shade of green and one of blue. When these are properly mixed they give the perfect colors that you see. So Baird a few

years ago, using mechanical scanning, employed a three-color disk.

During the recent CBS tests, Dr. Goldmark used the Cathode beam scanning at both transmitter and receiver plus many refinements which do him very great credit and which have resulted in very fine colored pictures on the receiving screen. But there are a great many imperfections in his method which make it impractical for commercialization.

As you know, the standard picture in black and white now is 441 lines, 30 frames or 60 fields, 60 scans per second. This is not well suited for three-color transmission, but very recently Dr. Alexanderson of the *General Electric Company* used the above arrangement for two-color transmission. He used the system that I first described as *Kinemascope* and the reports are that this two-color system gave very good results. However, the history of motion pictures in color shows that there is a distinct advantage, a nearer approach to realism, by the use of three colors over that of two. So I have no doubt, although I have not seen either one of them, that if you put them side by side, the CBS three-color, tri-chromatic would be in greater demand than the system used by Alexanderson of G. E.

Now, in order to get the three-color picture, Dr. Goldmark had to sacrifice a number of lines in the picture. You cannot get three colors with 441 lines and still stay in the allowed frequency band of six megacycles—four and a half megs for the picture and the rest of the band being used for the sound and to give the necessary separation between the allotted frequency and the next band. Consequently Dr. Goldmark reduced the number

of lines in his picture and doubled the scanning rate. Instead of 30 frames per second he used 60 frames or 120 fields per second. You will have to divide the 441 lines by the square root of 2 if you have doubled the number of frames per second. The square root of two is 1.41, and 441 divided by this figure is almost exactly 313 lines.

Now, if instead of 441 lines for black and white he had used the newer system standard of 507 lines, he would have had 360 lines in his color picture. So he compromised on 343 lines and 60 frames, or 120 fields per second. This means a vertical scan of 120 fields per second and a horizontal scan of 20,580 per second. (He has to do that, as I will show you, in order to get each color in front of the picture to be transmitted a sufficient number of times, and to reproduce them at the receiver an equal number of times so as to avoid a color flicker.)

If you had a succession of red, green and blue at the rate of 15 times per second, your eye would notice the color flicker and the effect would not be good. The schedule shown in the photograph will give you a better idea. The first scanning field is down on the odd number of lines—1, 3, 5, 7, 9, etc., while the next field you fill in these gaps on the even lines—2, 4, 6, 8, etc. The fields alternate, as you know, in scanning black and white. First the odd lines of one field and then the even lines of the other field as we go on down. Here each one of those fields is scanned in a 120th part of a second.

The color filters are introduced in front of the picture, between the picture and the pick-up tube, in this

(Continued on page 41)

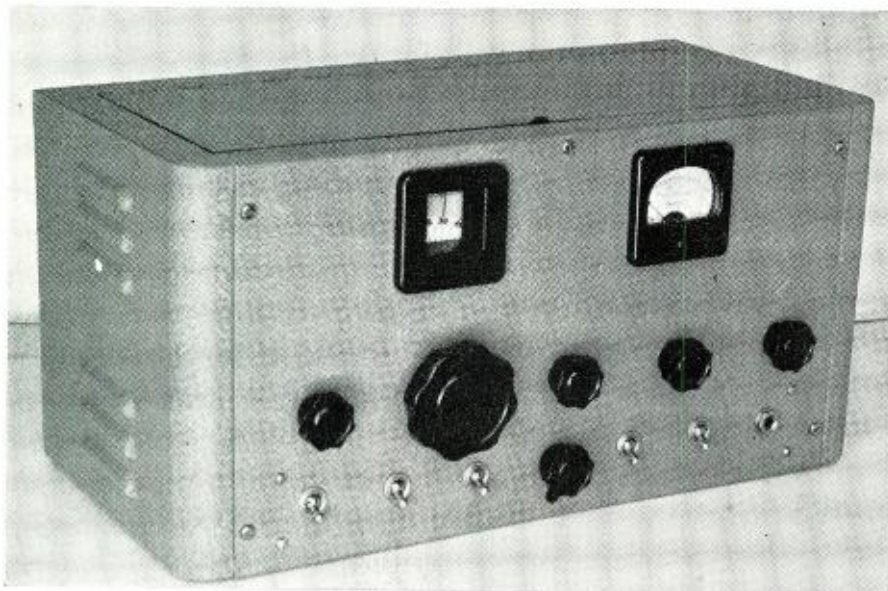

The unit has an "R" meter, is compact, and is tunable with one knob.

# ADVANCED BEGINNER'S SUPERHET

by **CLARK E. JACKSON**  
New York City, N. Y.

*Building a simple 6-tube superhet, featuring automatic band-set plug-in coils making the tracking easy to adjust. A nice ham receiver.*

**W**ITH the advent of a great number of new amateurs and short wave listeners and experimenters into the radio field, not only through the enormous number of classes being conducted by Uncle Sam for his soldiers, but also by private and commercial enterprises seeking to instruct our youth in radio, a great demand has arisen for a simple superheterodyne which the more advanced beginner could easily construct. The unit would have to be easy to build and more, or less, self-tracking since the alignment of superheterodynes is a problem not easily undertaken by the beginner. The unit to be described herein is a receiver which is self-tracking to the extent that each plug-in coil carries its own padding condenser with it, thereby eliminating the tracking between coils when shifting from one band to another.

There is nothing unusual about this receiver except its extreme simplicity of construction. The i.f. coils, which

are received from the manufacturer, are already tuned to the proper frequency of 465 kc. and should not be changed. Coil data furnished is exact and should be so followed. Alignment procedure thereupon becomes exceedingly simple and resolves itself simply to tuning the padder condenser located in the oscillator coil so that the coil will cover the band desired, as indicated in the band-spread condensers.

Although simple in the extreme, the little receiver gave excellent account of itself under extremely adverse conditions and signals were easily read from both coasts. The quality, while not superior, is certainly adequate for all communications work and it is only necessary that the constructor be familiar with simple tools if he wishes to undertake the building of this unit.

There are still many amateurs and short wave listeners who prefer to construct their own communication receiver. In some cases this is born of necessity, while in others it is because

the builder wishes to gain the experience had in layout and wiring of the set. A communications receiver does not need to be an elaborate instrument in order to attain satisfactory performance, in fact, many simple types are available commercially that are sold under the category of amateur equipment that do not include many of the features to be found in the set herein described.

First of all, we must decide upon these features that we would make use of in everyday operation. The circuit comes first. There is no substitute for the Super-het as far as general performance is concerned, so we decide on this circuit above the TRF types. Inasmuch as the amateur bands and the short wave bands are rather crowded, it will be necessary to design the circuit so that a high degree of selectivity will be had. The first experimental model of this set made use of two i.f. stages. The overall gain was more than needed and the set was unstable. The solution was to eliminate one of these stages to reduce the gain.

There is still plenty of sock in the one remaining stage, and the results have been most satisfactory. The transformers may be either of the iron-core type or the ordinary wood dowel variety. The use of loktal tubes is recommended. They will remain in the sockets if the chassis is subjected to jarring, have low loss construction, and are highly efficient. The 7A7 tube must be shielded in order to keep the circuit from breaking into oscillation. This is due to the amount of gain available in the i.f. stage.

Next in importance is the means for changing bands. The simplest is to use plug-in coils in place of the more elaborate band switch assemblies. Many builders already have a supply of these on hand and they may be used to good advantage. No r.f. stage is included as this would complicate matters for the average builder that might not have the necessary knowledge for the tackling of the tracking problem.

Band-spread is included so that the stations may be spread out on the dial for easier identification. A padder condenser is mounted in each of the oscillator coils and these are used to set the bands for proper coverage. Another condenser of the same type may be used across the antenna winding if required. Tuning is done by means of two midget condensers that are ganged as shown. One of these has a capacity of 35 mmf. while the other has a capacity of 50 mmf. This allows an even tracking of the mixer circuit without resorting to condensers having a special oscillator plate design.

Automatic-volume-control is included to aid in keeping the signals at a constant level. The 7B6 is the diode detector, a.v.c., and first audio tube. Headphone reception is provided for by wiring in a phone jack after this stage. A switch is used so that the a.v.c. may be removed for the reception of c. w. signals.

A signal-strength meter is highly desirable in order that the operator be able to give an accurate report on the received signal, and to enable him to tune the set properly. This meter is a

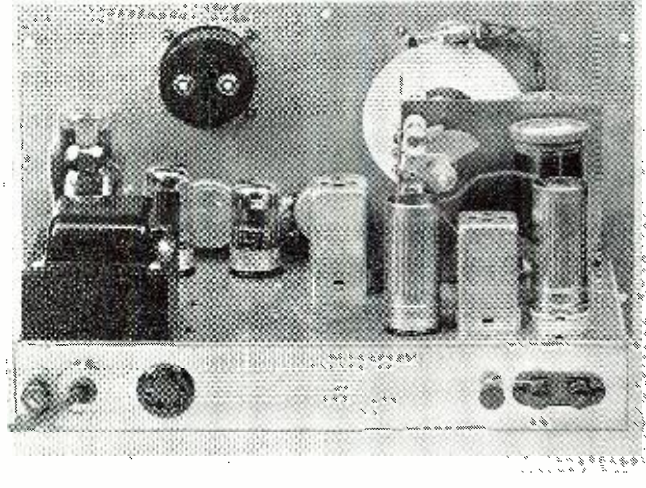
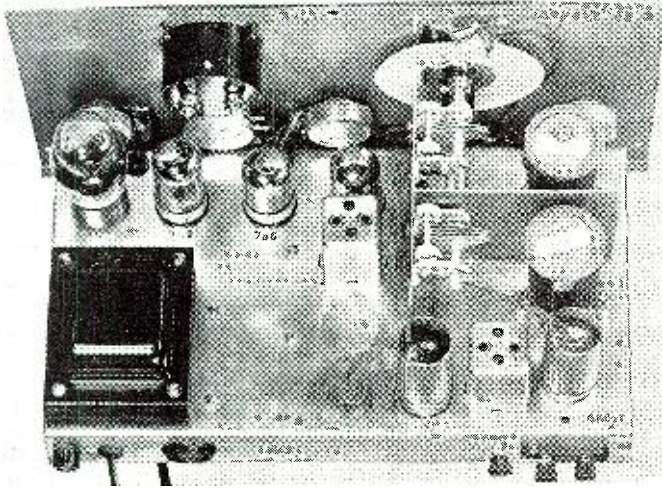

Two top-side chassis views.

standard *Triplet* R meter—essentially a 0-1 DCMA that has a scale calibrated in R's. A variable shunt resistor is placed across this meter so that it may be adjusted to the proper position.

A beat-frequency oscillator is an essential for the reception of code and is included. The unit is mounted beneath the chassis so that the coil may be tuned to the desired pitch frequency.

Two gain controls are used—one for the r.f. stages and the other to set the audio gain. It will be found best to keep the r.f. control almost *full-on*, and to adjust the audio control to the volume desired.

**Construction**

The complete receiver is mounted on a single chassis which measures 12"x7"x3". This includes the complete power supply. The general layout of all parts is clearly indicated and no pictorial diagram was felt to be needed. The leads in all of the tuned circuits should be kept as short as possible. Do not attempt to be too neat as to do so may lengthen the leads far in excess of their requirements. After all of the parts are mounted we may proceed with the wiring. Do the filaments first, followed by the cathode circuits, a.v.c, audio, plates, etc.

Note that all of the controls are mounted on the panel. The tuning dial is provided with a window that

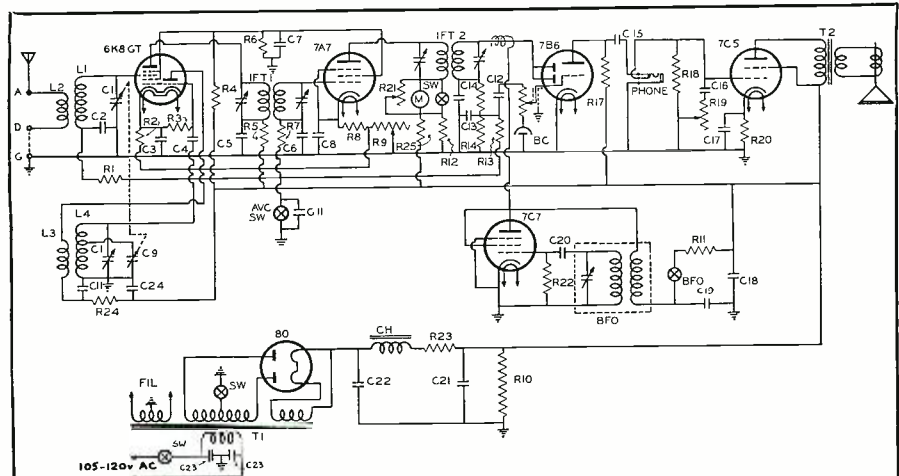

- C<sub>1</sub>—50 mmf. Hammarlund MC50M
- C<sub>2</sub>—50 mmf. Hammarlund APC50
- C<sub>3</sub>—.05 mfd. 400 v. paper Mallory
- C<sub>4</sub>—.05 mfd. 400 v. paper Mallory
- C<sub>5</sub>—.00005 mfd. mica Mallory
- C<sub>6</sub>—.05 mfd. 400 v. paper Mallory
- C<sub>7</sub>—.05 mfd. 400 v. paper Mallory
- C<sub>8</sub>—.1 mfd. 400 v. paper Mallory
- C<sub>9</sub>—.05 mfd. 400 v. paper Mallory
- C<sub>10</sub>—.35 mmf. Hammarlund MC35M
- C<sub>11</sub>—.01 mfd. 400 v. paper Mallory
- C<sub>12</sub>—.5 mfd. 200 v. paper Mallory
- C<sub>13</sub>—.02 mfd. 400 v. paper Mallory
- C<sub>14</sub>—.0001 mfd. mica Mallory
- C<sub>15</sub>—.0001 mfd. mica Mallory
- C<sub>16</sub>—.05 mfd. 400 v. paper Mallory
- C<sub>17</sub>—.02 mfd. 400 v. paper Mallory
- C<sub>18</sub>—.20 mfd. 50 v. electro. Mallory
- C<sub>19</sub>—.1 mfd. 400 v. paper Mallory
- C<sub>20</sub>—.05 mfd. 400 v. paper Mallory
- C<sub>21</sub>—.00025 mfd. mica Mallory
- C<sub>22</sub>—.8 mfd. 450 v. electro. Mallory
- C<sub>23</sub>—.8 mfd. 450 v. electro. Mallory
- C<sub>24</sub>—.1 mfd. 400 v. paper Mallory
- C<sub>25</sub>—.005 mfd. mica Mallory
- R<sub>1</sub>—100,000 ohms, 1/2 w. IRC
- R<sub>2</sub>—400 ohms, 1 w. IRC
- R<sub>3</sub>—50,000 ohms, 1/2 w. IRC
- R<sub>4</sub>—25,000 ohms, 1 w. IRC
- R<sub>5</sub>—10,000 ohms, 1 w. IRC
- R<sub>6</sub>—50,000 ohms, 1 w. IRC
- R<sub>7</sub>—100,000 ohms, 1/2 w. IRC
- R<sub>8</sub>—300 ohms, 1 w. IRC
- R<sub>9</sub>—25,000 ohms pot., Mallory
- R<sub>10</sub>—50,000 ohms, 25 w. Ohmite
- R<sub>11</sub>—50,000 ohms, 1 w. IRC
- R<sub>12</sub>—100,000 ohms, 1/2 w. IRC
- R<sub>13</sub>—100,000 ohms, 1/2 w. IRC
- R<sub>14</sub>—500,000 ohms, 1/2 w. IRC
- R<sub>15</sub>—100,000 ohms, 1/2 w. IRC
- R<sub>16</sub>—500,000 ohms pot., Mallory
- R<sub>17</sub>—250,000 ohms, 1 w. IRC
- R<sub>18</sub>—500,000 ohms, 1/2 w. IRC
- R<sub>19</sub>—250,000 ohms pot., Mallory
- R<sub>20</sub>—350 ohms, 10 w. Ohmite
- R<sub>21</sub>—2,000 ohms pot., Mallory
- R<sub>22</sub>—50,000 ohms, 1/2 w. IRC
- R<sub>23</sub>—1,000 ohms, 50 w. Ohmite
- R<sub>24</sub>—30,000 ohms, 1 w. IRC
- R<sub>25</sub>—1,000 ohms, 1 w. IRC

- Dial Millen
- Sockets—Millen; R Meter—Triplet 221
- Tubes—Sylvania
- Coil forms—Hammarlund SWF4 and SWF5
- T<sub>1</sub>—Plate and fil. trans., Thordarson T-13R08
- T<sub>2</sub>—Output trans., Thordarson T-17S57
- CH—Filter choke, Thordarson T-14C92
- IFT<sub>1</sub>—456 KC input Meissner 16-6659
- IFT<sub>2</sub>—456 KC output Meissner 16-6660
- BFO—Meissner 17-6753

**COIL DATA**

	Coil	Wire	Turns	Length	Tap	Diameter
1.75 mc. Band	L <sub>1</sub>	24	70	Close Wound	At grid end	1 1/2"
	L <sub>2</sub>	24	15			
	L <sub>3</sub>	24	15			
	L <sub>4</sub>	22	42			
3.5 mc. Band	L <sub>1</sub>	22	35	Close w. Close w. Close w.	18th from ground	1 1/2"
	L <sub>2</sub>	22	9			
	L <sub>3</sub>	22	10			
	L <sub>4</sub>	22	25			
7 mc. Band	L <sub>1</sub>	18	20	1" Close w. Close w. 1"	6th from ground	1 1/2"
	L <sub>2</sub>	22	5			
	L <sub>3</sub>	22	6			
	L <sub>4</sub>	18	14			
14 mc. Band	L <sub>1</sub>	18	10	1" Close w. Close w. 1"	2 1/2 from ground	1 1/2"
	L <sub>2</sub>	22	5			
	L <sub>3</sub>	22	4			
	L <sub>4</sub>	18	7			
28 mc. Band	L <sub>1</sub>	18	4	1" Close w. Close w. 1"	1 1/2 from ground	1 1/2"
	L <sub>2</sub>	22	4			
	L <sub>3</sub>	22	2 1/2			
	L <sub>4</sub>	18	3 1/2			

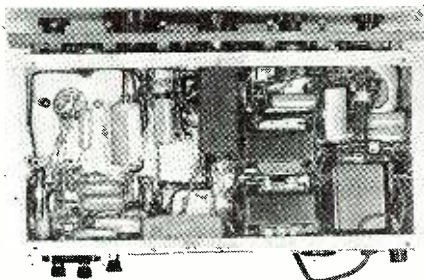
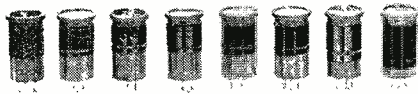

All band coils are shown above and an under-chassis view appears below.

matches the general appearance of the tuning meter. This makes a neat layout and convenient arrangement.

The plate and filament transformer is mounted on the chassis with all of the flexible leads passed underneath the chassis. The balance of the power supply components are all mounted underneath the chassis where they will be accessible.

Shielding between the Antenna and r.f. stage is highly important. A baffle is constructed from light gauge erado metal. This may be seen between the two coils. Another piece is cut and fitted at a right angle to the baffle and both of the tuning condensers are mounted directly onto this. The bottom edges are soldered to the chassis so that no vibration can occur and to keep the assembly rigid.

The tube lineup is as follows: 6K8GT mixer-oscillator, 7A7 i.f., 7B6 detector, a.v.c, 1st audio, 7C7 b.f.o., 7C5 output, and 80 rectifier. The resistor R23 is used if a transformer having a higher voltage than the one used in this set is used as a substitute. At any rate, the output voltage from the filter should not exceed 250 volts. The screens operate at a maximum of 100 volts.

The cabinet measures 16 1/4" x 8" x 8 1/4". Plenty of space for proper ventilation is available. Enough space remains on the interior for storing the spare coils.

After the voltages have been set at the proper operating point, the i.f. stage should be trimmed to 456 kc. with an r.f. oscillator, beginning at the secondary of the output i.f. transformer. The osc. output connects to the grid of the 6K8 mixer tube through a condenser of .0001 mfd. The receiver and oscillator must have a common ground as well. After each i.f. transformer has been tuned properly, the 160 meter coils may be inserted and the oscillator connected to the antenna posts of the set.

The trimmer condenser mounted within the oscillator coil should be set so that the low frequency edge of the band is tuned when the tuning condensers have their plates fully meshed. Then the signal is set to the high end of the band and there should be about 50 kc. still left over. The band may also be centered by setting the oscillator signal to 1850 kc. with the tuning condensers set to read 50 on the dial. This will allow some leeway at both outside edges of the band.

The same procedure is recommended for the proper setting of the other coils. Bandspread is adequate for easy tuning, and the tracking is fairly accurate over the range of any one band. If the builder wishes to have full coverage from the receiver, he may use an alternate arrangement for tuning.

The band-spread taps on the oscillator coil would be disregarded and separate band-setting condensers, each of 50 mmfd. capacity would be used. These may be mounted on the panel instead of within the coils and set by hand so that any portion within the range of each set of coils may be tuned by the ganged units.

**Oops, So Sorry!**  
Refer to "High-Fidelity Tuner"—  
January, 1941 issue RADIO NEWS  
Page 23.  
C3 should be 8 mfd. 450 volt electrolytic  
Mallory condenser.



by ALFRED TOOMBS

Special Washington Correspondent for RADIO NEWS

### Washington Rigmarole

**T**HE hottest thing in Washington today is the appointment of Knudsen to the post of Production Chief of the *National Defense Board*. Not only has the Board been operating in the past without any sort of a Chief other than President Roosevelt, but the lack of such a Chief has caused numerous squabbles in the High Places. It is hoped that now that Knudsen has been given everything that he has asked in the way of power, that these differences will be ameliorated and that the *American Defense Program* will proceed at top speed. Naturally, this also applies to Radio, although in this last field there has been considerably less friction than in almost any other part of the Defense Program.

It is reported the *American Radio Relay League* has been making representation to the *Federal Communications Commission* looking toward the lowering of standards of admission to the ranks of the licensed amateur. It is said the *ARRL* feels that there should be more amateurs and, accordingly, has asked the *F.C.C.* to make the entrance examinations leading to a license a little easier. Code restrictions will be lowered instead of raised and it may become a possibility that amateurs will be licensed with considerably less than 13 w.p.m. code speed requirements and lighter technical requirements. The exact code speed prerequisite is not known by your correspondent, but it is supposed to be in the neighborhood of 4 to 5 w.p.m.

The real reason behind this move is to obtain many more radiomen familiar with the operation of transmitters and receivers than is now possible without an extra and added expense to the Government. In spite of the fact that Uncle Sam is spending thousands of dollars in teaching his soldiers radio, the American ham stands supreme as a self-taught man, and by lowering the standards of admission to license it is felt that the number of hams in the United States could easily be doubled. This would cause a pool of from 100,000 to 125,000 radiomen to be available on short notice to Uncle Sam and without any expense to him. The reaction to this program, when it hits the amateurs, is awaited with interest.

The appointment of eleven sub-committees by the *Defense Communications Board*, the body which will rule the air waves if the shooting starts, clears the decks for some real action to tighten the defenses of our country's weakest front—the ether.

Can the hams be allowed to stay on the air if we are involved in hostilities? How can their talent and equipment be used? What will be the Government attitude toward Labor Unions in the radio field. Where are we going to find enough frequencies for all the essential radio services? How quickly can aviation radio be switched to UHF? What steps should be taken to guard police and public utilities radio systems from sabotage?

These are a few of the headaches picked at random from the plain and fancy assortment which the *DCB* handed its sub-committees. There are dozens of others—every one of which may vitally affect you. The chances are that you, as an amateur or propagator, are represented in some way on the *DCB* set-up. Since these committees are getting ready to make rules that may affect your profession or avocation, you would do well to let your representative know your wishes and ideas.

Look up the names of the organizations to which you belong on the list of members of the sub-committee which appears in this magazine. Let them have your ideas on radio defense. If you feel that your organization is entitled to representation on one

of the committees, write to Chairman Fly at the *FCC* and tell him. He informed the writer that the sub-committees would add representatives of any groups legitimately entitled to membership.

The Amateur sub-committee, in which you will probably be most interested, includes six members and six advisors, at present. The *ARRL* has been asked to appoint one member and six advisors, to be chosen by the *League's* Board of Directors. The representatives are to be chosen on a regional basis to speak for radiotelegraph and radio-telephone ops and amateur emergency nets.

In addition to the *ARRL* representative, the committee will have one member from the *American Legion Radio Net*; an *FCC* representative, Mr. E. M. Webster of the Amateur section; a Navy man, Lieut. Comdr. John L. Reinartz, who is in charge of the *Naval Communications Reserve* hamnet; an Army man, Major Frank C. Meade, who formerly was connected with the Army amateur net, and an official of the *National Youth Administration*, whose name has not yet been announced.

Conversation with the Government representatives on this committee reveals strong sentiment for keeping hams in operation to as great an extent as is possible in a war emergency. It appears that if this country goes to war all hams *WILL NOT* be chased off the air, as they were last time.

"Can you guarantee there won't be any hurricanes in New England or in Florida? Will you promise there'll be no floods in the Ohio or earthquakes in California?" one member of the sub-committee replied when we asked him if the group intended to black out the hams.

There are, at present, some 50,000 ham tickets in this country. Obviously, in war time, the Government could not allow that many stations to operate. But inside information seems to indicate that a considerable proportion of the hams, after proper investigation, will be allowed to work.

Probably, those who stay on the air will be included in the Army amateur system. Or perhaps in a special defense net. The sub-committee, we have learned, will discuss the possibility of including hams in an auxiliary air raid warning system.

Under any circumstances, the ham and his station will be used to the fullest extent. There is no blackout of the hams contemplated during the next war, at this writing.

### Radio Censor

**T**UCKED away in the membership lists of the Domestic Broadcasting and International Broadcasting Committees is a little surprise package. The managers of our broadcasting systems, when they discover the package, may find it ticking ominously—like a bomb.

The surprise is Lowell Mellett, gray and sardonic No. 1 man of the brain trust these days. It is popularly supposed in Washington that Mellett, a newspaperman all his life, would become "propaganda minister" if we were at war. Mellett was, for many years, editor of the *ScrIPps-Howard* paper in Washington, resigning when its editorial policy began to get under his liberal skin.

He took charge of the *National Emergency Council*, a somewhat mysterious Government agency which was to be the super-directing force behind Government press agency.

Gaining White House favor, he became one of the President's assistants "with a passion for anonymity." Currently, he is rated as possibly the closest man in Washington to Mr. Big. He is for a free press and free radio—but believes the former has over-

(Continued on page 46)

# SERVICES FOR M. RECEIVERS

At the present time there are three well-known makes of radio receivers which incorporate frequency modulation: *Stromberg-Carlson*, *General Electric* and *Scott*. Various kits, too, are on the market, such as *Browning* and *Meissner*, which may be wired and assembled by the serviceman or experimenter. In all of these sets fundamental principles remain the same, but differences may exist in the prescribed methods of alignment.

For example, *General Electric* recommends the use of frequency modulated oscillator in conjunction with cathode ray oscilloscope in tuning their chassis, while *Stromberg-Carlson* advises the test oscillator and microammeter method. Both have their advantages and disadvantages and the choice of the method you may want to use will depend upon your pocket-book.

Some very fine test equipment is offered by various manufacturers for testing frequency modulation sets, but, after much consideration, the writer decided on the following: *Weston Model 787 U.H.F. Oscillator* and two *Weston Meters*, an 0-200 microammeter and a 100-0-100 microammeter. A d.c. vacuum tube voltmeter could have been used in place of the zero center 100 microampere meter, but it was considered that the investment was worthwhile considering the relative simplicity and usefulness of the instrument.

In addition to the above, a stable oscillator which will hold its frequency and not shift too much is needed for the 2.1 mc. intermediate frequency alignment of f-m receivers manufactured by *Stromberg-Carlson* and *General Electric*. The *Scott* chassis uses a 5.25 mc. frequency for its f-m i.f.

by **WILLARD MOODY**

New York City, N. Y.

## Some pointers for the serviceman to be used in servicing the newer types of F.M. receivers.

and this is one of the differences of this set as compared to the first two sets. *Browning* uses a 3 mc., while *Meissner* uses 4.3 mc. intermediate frequency. In most service shops there are already available good and accurate signal generators which will serve to provide the necessary intermediate frequencies mentioned.

In aligning the f-m receiver, work should start at the differential detector, which is no more or less than our old friend the discriminator used in automatic frequency control on the broadcast band. A signal of the correct intermediate frequency, which we shall assume is 2100 kilocycles or 2.1 mc., is fed into the grid circuit of the limiter tube, using a series capacitor of .1 mfd. About one volt or full signal generator output power is needed. The primary of the detector transformer is tuned to resonance by observing the deflection obtained when the zero center microammeter is connected in series with a one megohm resistor across the .1 meg. resistor of the diode load network. This resistor is marked "A" in the diagram of the typical f-m receiver which accompanies this article.

Next step is the adjustment of the detector transformer secondary. The microammeter with one meg. series resistor is connected across the full diode load, resistors "A" and "B". Trimmer 1 is then adjusted for zero center on the meter. Note that a good strong signal is used and not a weak one as in broadcast superheterodyne alignment. This is necessary, as otherwise the detector would not be in correct alignment when operating under normal conditions in the presence of received f-m signals.

The identical alignment frequency used for the detector tuning adjustments must be used for lining up the limiter and i.f. circuits. This means signal generator stability and careful usage of the generator. The generator is shifted to the grid circuit of the second i.f. tube, using a series capacity of .1 mfd. and disconnecting the lower

side of the 6SJ7 Limiter's grid resistor at the point marked X in the diagram. A 0-200 microammeter is inserted here to read limiter grid current. The third i.f. transformer secondary is tuned to the 2100 kc. i.f. by watching the microammeter, tuning for maximum grid current. The adjustment is similar, in some respects, to tuning of a Class C stage in a transmitter. The trimmer is number 3 in the diagram. Trimmer 4 is adjusted next. The generator is now shifted to the first i.f. grid and trimmer number 5 is peaked, followed by 6. Next, the signal is fed into the 6SA7 mixer grid and trimmers 7 and 8 are tuned for maximum grid current as in all the preceding i.f. adjustments. No attempt should be made to "stagger" the i.f. circuits by slightly detuning one capacitor in one direction and a second capacitor in another. It won't work and will lead to negative results. The shunt resistor and coupling coefficient of the individual i.f. transformers assure a broad band-pass without the necessity for special alignment. Directions must be followed to the letter, as mentioned in manufacturer's data.

Following i.f. alignment, the signal generator is connected to the proper input terminal of the receiver, through a 100-ohm resistor. If the receiver has a low frequency adjustment for the oscillator, the dial is first set at 40 mc. or whatever the specified frequency may be, such as 39 or 39.5 mc., and the oscillator is tuned to the signal generator output. If the generator does not have a fundamental output of 40 mc. as the *Weston 787* does have, then the harmonic frequency of the highest available frequency must be used. Usually, this will be 20 mc. and the second harmonic will be used. The generator should, of course, be as accurate as possible.

The high frequency end of the band is next set by adjusting the shunt trimmer of the oscillator in the receiver to 43 mc. or whatever the alignment frequency of the particular set may be.

(Continued on page 58)



The Scott F.M. receiver in cabinet.

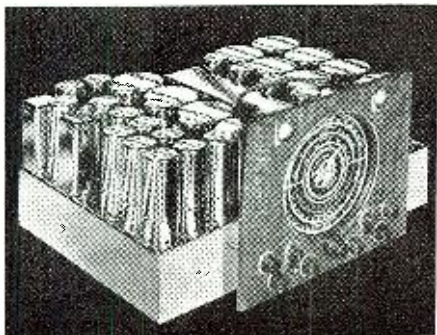

The Scott F.M. receiver chassis.

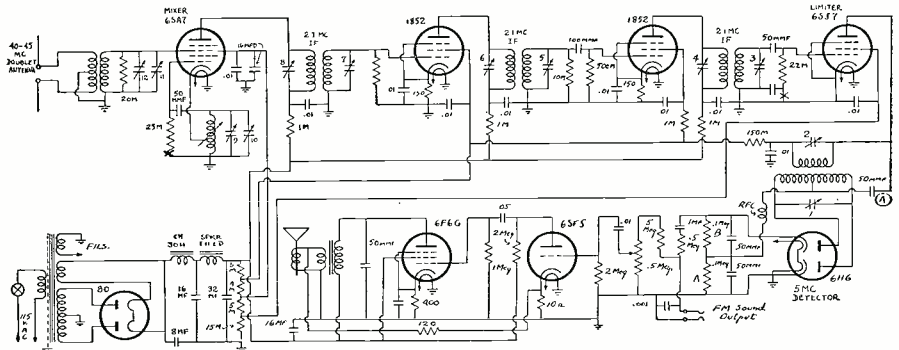

Typical F.M. receiver circuit diagram. (After Stromberg-Carlson)

# A S . . . S E E . . .

by **JOHN F. RIDER**

*Dean of the Servicemen*

## Test Equipment Standards

IN the two decades which have passed since the inception of general radio broadcasting, many things have happened. Among these occurrences has been the development of standards for the many branches of the radio industry, technique and components. No one can deny that such standards have contributed greatly to the stabilization of these branches of radio activity, at least from the viewpoint of engineering technique and application, even if there is no stabilization of activities from the sales viewpoint.

In line with these accomplishments, it seems to us that the time has come for some kind of standardization in radio service test equipment. By this we do not mean to cast any reflections upon the integrity of the test equipment manufacturers or to suggest that all test equipment be similar in character. The freedom of design which has existed heretofore can prevail in the future, but there is need for definite clarification of the many considerations and terms associated with service test apparatus. Such a step will help not only the radio serviceman, but the test equipment manufacturer as well and will further reflect advantages to the service industry.

It is a well-known fact that the radio serviceman is not aware of either the requirements of the servicing industry or of the limitations in test equipment manufacture with respect to *what can be furnished* by the manufacturer *at a price*. Because of lack of knowledge of the latter character, much valuable information associated with the design and application of test equipment is never furnished to the radio serviceman. Since neither specific standards or specifications exist, it is possible for those who write advertising literature to play upon words, not necessarily with the intent to mislead, but, to say the least, to make the most of a situation.

Maybe the situation has not been productive of much harm, but as the industry grows and its needs multiply and its expenditures rise, the value of standards becomes more and more evident. Let us cite a few examples of what we mean.

To start with, suppose we speak about signal sources. We have several types, namely those which technically rate as being test oscillators and those which are signal generators. Since design and price, both of interest to the serviceman, are related to the proper definitions of these units, it might be well for the servicing industry to establish, or have established, standards which will define such devices, in which event magazines will have available for their use certain yardsticks whereby they can render some badly needed decisions concerning the contents of advertisements.

In contrast to the signal source which provides coverage over a variable frequency range are the units

which generate a highly complex wave such as that provided by a multi-vibrator. This type of units is destined to meet abundant use, consequently proper identification is necessary with respect to its application and qualifications so that the servicing industry will properly appreciate what can be done and what cannot be done with the unit.

Paper is very patient and it is possible to describe all things in flowery language. There need be no definite attempt to say things which are not so, yet create impressions of conditions which do not exist. In this respect we feel that test equipment manufacturers and servicemen alike would welcome some basis of comparison which is logical and understandable. What is a signal generator? What is a test oscillator? What is a *plain* signal source? We know that in the final analysis all provide a test signal, but since some are more expensive than others, is it worthwhile spending the money asked for any one product? And if it is being spent, is money's worth being received? If one type of device is in one class because of engineering design, then standards should be established so that some other device selling for a small fraction of the cost should not be called by the same name and thus create confusion in the minds of the purchaser.

Continuing with the subject of signal sources, what is needed accuracy of the output attenuator and what should be the minimum accuracy for units in different classifications? No one says that they should be the same for all units, but some minimum standard should prevail, particularly when it is a well-known fact that perfection is impossible. Be that as it may, some basis of comparison should be available. The accuracy of the output attenuator setting varies with frequency. This should be known and appreciated. The same applies to accuracy of frequency calibration. What is needed for all practical purposes? What should be the minimum in devices which are identified as signal generators—as oscillators? What leakage is permissible over the different frequency bands in the different types of units? There is no sense in ignoring the fact that a certain amount of leakage exists in practically all units. True, that it is lowest and sometimes negligible over the broadcast band, but since receiver sensitivity is a paramount item on all bands and practically all receivers are of the multi-waveband variety, the leakage from the signal source is an important item.

But it is not only oscillators we are interested in. Vacuum-tube voltmeters are daily increasing in importance and use. What should be the minimum accuracy? What should be the minimum drift due to grid current? Items of this character once established will result in better equipment for the serviceman and provide him with a basis of comparison for



John F. Rider

value as against price. You get what you pay for and never more. No one has succeeded in giving \$100 worth for \$50 and remaining in business . . . at least not very long!

Tube checkers are also subject to observation. What should be the basic operations or measurements possible with a tube checker? Establishing such minimum requirements does not prevent anyone from providing more applications in the device he is manufacturing, but at least there is some common ground upon which comparison can be made. The servicing industry is confronted with the problem of deciding upon value received for the money asked. Confidence in the respective manufacturers is something the manufacturer must worry about but a basis of comparison between different test units is something the serviceman needs.

What should be the safety factor employed for the components used in test equipment? Should the price of the device determine the safety factor? Our personal belief is that some minimum safety factor should exist which will protect the buyer of low-priced test equipment. The high priced unit can employ a much higher safety factor, if the manufacturer is willing to spend the money, but whether he does or does not offer greater operating life, some minimum standard should be established. Minimum standards should be established for all of the components. If this is done, utmost protection is offered the customer and the test equipment manufacturer who attempts to chisel his way in, would find that there is more to the sale of test equipment than just claim after claim.

This discussion can be carried on over many pages, but we do not think it necessary, for what has been said so far should illustrate the value of such standards. Who would set these standards, we do not know. Maybe it would be the function of the *IRE*; maybe it would be a committee of test-equipment manufacturers and service groups; maybe it would be the test equipment manufacturers, members of the service groups and the *RMA* Service Committee of the receiver manufacturers. The important thing is the selection of a committee familiar with the practical requirements of the servicing industry and a knowledge of the relationship

(Continued on page 65)

# RADIO UNDERGROUND RIVER TRACER

by **CAPEL W. McNASH**  
Cleveland, Ohio

**How a blind amateur is using his hobby to locate and trace an underground river.**

BLIND Tiffin, Ohio, radio amateur, assisted by a group of enthusiastic fellow "hams," has successfully begun a job by radio which has defied scientists for years—the tracing of Ohio's famous underground river.

Henry J. McFerren used a two-tube ultra-short wave radio transmitter to "see" the underground river never viewed by human eyes.

The Tiffin inventor, who also is a successful manufacturer and refrigeration engineer, enlisted the aid of fellow radio amateurs from Cleveland and Columbus, Ohio, to help him in the manipulation of directional antennae with which he took cross-bearings on the little transmitter as, safely sealed in a rubber ball, it rode the subterranean currents of the river.

The transmitter McFerren used put out a 112,000 kilocycle carrier wave—two and one-half meters. Besides the oscillator tube was a modulator which put out a note of about 1,500 cycles.

The entire radio set, with battery and the rubber ball in which it rode, weighed only two pounds. McFerren had the ball fabricated especially for the experiment, and carefully placed the set—batteries in the bottom—in it and sealed the top. The tiny radio fitted snugly in the eight-inch ball, and a steel antenna, about 18 inches long, extended from the top of the sphere.

Because of the placement of the weight of the batteries, the little

vessel floated upright, with a displacement of several inches.

McFerren and his aides launched the ball in the seventh level of Seneca Caverns, near Bellevue, Ohio, after several months of preliminary tests by the inventor convinced him that the little set was capable of sending a signal up to 30 miles through the earth's crust. Early calculations indicated that the batteries were capable of putting out current for a day or so—more than enough to complete the experiment.

It was not the first time that objects had been launched in the river in an attempt to trace its course.

Sealed bottles had been dropped into the Bellevue underground stream on a number of occasions—but they never showed up anywhere, as far as is known.

The Ohio Board of Health, seeking the source of typhoid fever, put quantities of aniline dye in the stream, but no traces ever appeared in any surface stream.

The most popular theory is that the stream, which runs under the city of Bellevue, finally comes up at the Blue Hole, a remarkable natural wonder near Castalia, Ohio.



The inventor of the rubber-ball tracer, W8FUO.

The Blue Hole is a huge spring, which pours forth some 5,000 gallons of water an hour to form a surface stream.

In almost all previous attempts to send colored corks, sealed bottles or dyes via the subterranean stream, the Blue Hole was watched carefully, but unavailingly.

McFerren decided that the only way successfully to trace the stream would be by radio, so he worked out his design and completed its construction.

The plan called for a large number of amateurs to aid by manning directional antennae.

Two brothers from Cleveland, Wesley and Robert Boden traveled to Bellevue for the experiment.

Robert Cull, a graduate of the Mas-

(Continued on page 59)

J. D. Brewer and the direction finder.



Wesley (left) & R. Boden, aiding W8FUO.



R. Cull, of M.I.T., who assisted work.



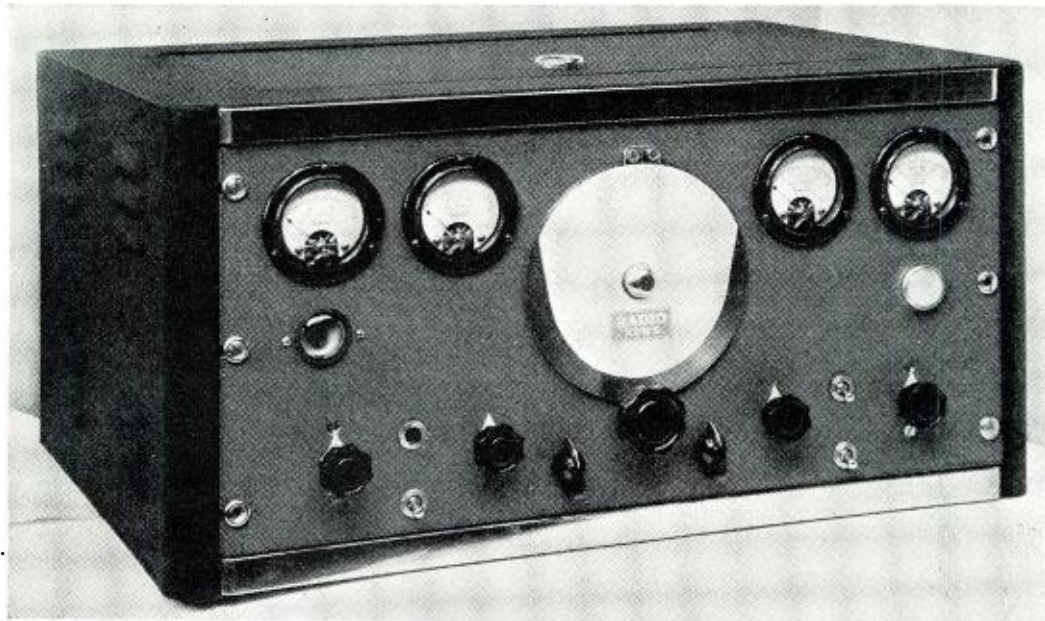

The transmitter is "table-mounting." With external modulation, it becomes a 'phone unit.

# A CALIBRATED EC 80-20M. TRANSMITTER

by **KARL A. KOPETZKY, W9QEA**

Managing Editor, RADIO NEWS

*Using the beat-note of a broadcast signal  
to calibrate and set an amateur ECO xmtr.*

✓ THERE has been a definite trend in the past year toward the electron coupled oscillator type of transmitter. One of the main advantages of this type of unit is freedom to move the signal within the band or even over a series of bands wherever the owner may care to place his signal. The attendant difficulty of this type of transmitter has been its inherent inability usually to be calibrated with any great degree of accuracy.

The unit designed and described by the author seeks to overcome this difficulty by utilizing a signal from a broadcast station as a marker. One may wonder why the signal from the broadcast station was picked in place of one, say, from WWV. The reason for this is that the signal from the broadcast station can be used to activate an electronic eye. The FCC requirements on broadcasters compels these stations to keep such close and narrow tolerance limits that for all amateur purposes, and any broadcast station properly licensed and operating within the United States can be used as a means to set the ECO transmitter and enable the owner to be well within the law requiring the operation of ham transmitters to be within their respective bands.

## Electronic Eye Operation

The magic eye frequency monitor included in the unit makes use of one of the oldest "bugaboos" of amateur radio. Every amateur is thoroughly familiar with broadcast interference. It seems that whenever he goes on the air some broadcast station reception at some BCL's home is accompanied by an undesirable heterodyne whistle.

Since the broadcast station frequency does not vary perceptibly, it occurred to the author that the heterodyne whistle set up by the transmitter and the B.C. station could be used as a means of locating the frequency of the former unit.

In test work in the laboratory it was found that this theory worked excellently. The method of operation is as follows:

Connect the unit to a power source of 115 volts a.c., turn on the filaments, and allow the units to heat. Throw the switch controlling the power to the buffer and final amplifier stages so that the high voltage is *disconnected* from these two tubes. Turn the high voltage on, it being put on the receiver and the oscillator plates only.

Turn the "band-set" E.C.O. condenser, C1, until it is almost fully engaged. Tune the receiver condenser, C24, until a broadcast station in the neighborhood of 700 to 800 kc. is heard. Check this by means of the earphones plugged in the front. Leaving the earphones plugged in, tune "band-spread" E.C.O. condenser, C1A, until the loudest beat note is heard in the earphones. Several beat notes will be heard, and the constructor is cautioned to choose the loudest one. This beat note will also "close" the magic eye. It is now only necessary to tune condenser, C1A,

to zero beat with the broadcast station signal being tuned on the condenser, C24, and the "marker" position of the "band-set" E.C.O. condenser, C1, has been fixed.

It will be noted that the audio component of the broadcast signal causes the eye to flicker. This is normal. On this flicker will be superimposed the off-beat heterodyne of the E.C.O., which will close the eye (should the eye overlap, potentiometer R24 should be so adjusted that the eye just closes when the heterodyne note is the loudest). At zero beat, then, there will be no heterodyne note heard in the earphones, and the "eye" will *show only the audio component of the broadcast signal*.

If the E.C.O. should drift or be disturbed slightly, the beat heterodyne will cause the eye to show a "double" light spot in its "V." This is the heterodyne beat note being superimposed on the audio component of the broadcast signal. By experimenting with the earphones plugged in, and listening, and observing the eye at the same time, the constructor will soon learn to differentiate between the flicker caused by the audio component of the broadcast signal, and the overlapping caused by the superimposition of the heterodyne beat note over the audio component.



The theory of operation is as follows:

In Chicago, for instance, we used WBBM as the marker station. Since WBBM operates on a frequency of 770 kc., the oscillator of the superheterodyne is operating on 1226 kc.; the difference between this frequency and WBBM being 456 kc., the i.f. frequency. By placing the E.C.O. oscillator on 1682 kc., as described above, this frequency will beat with the superheterodyne oscillator frequency of 1226 kc. to give a resultant frequency, which is the difference between the two frequencies, 1682 kc. minus 1226 kc., or 456 kc.—again the i.f. frequency. Since it is assumed that the WBBM frequency is "fixed" and that should the oscillator of the receiver drift, it can be reset by tuning WBBM "on the nose" any resultant change in the setting of the E.C.O. grid circuit will be noticed as a beat heterodyne note at the output of the superheterodyne receiver, and a resultant change in the "eye" pattern.

It was with such a background that the E.C.O. chassis was designed to contain a complete superheterodyne receiver less the usual power-audio stages. This superheterodyne receiver tunes from 550 kc. to approximately 1700 cycles, and the oscillator of the E.C.O. transmitter section is beat against a suitable broadcast station causing electronic eye in the output of the superheterodyne receiver to close. In order to make use of this function, the E.C.O. grid coil is arranged and designed to tune from approximately 1600 kc. to about 2000 kc. The grid coil of the oscillator tunes from 1600 kc. to 2000 kc. while the plate circuit of the E.C.O. is so designed to operate at either the 80 or 40 meter bands with plug-in coils. No provision is made for changing the grid coils, which is always in the 1600-2000 kc. band. Calibration, therefore, is very simple.

Once a "marker" position is found as will later be described and marked on the white cardboard dial glued to the  $5\frac{1}{2}$ " *Browning* band-spread dial, the E.C.O. grid coil then has a point from which it may be calibrated.

Having this one reference point, it is a comparatively simple matter to calibrate the entire 40, 20 and 10 meter bands with accuracy.

Calibration of points from 3500 kc. to 4000 kc. may be obtained either with

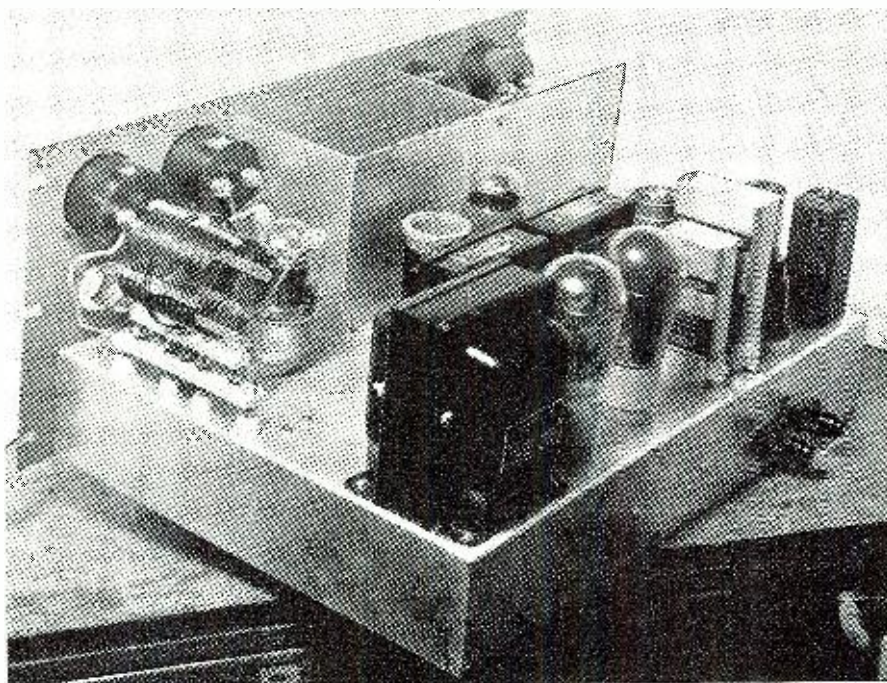

Note the shielding employed to make for stable operation.

the cooperation of a number of amateurs with crystals, or by means of a signal generator utilizing the broadcast signal, which has previously been "marked" as a reference point in either case.

#### Construction

The entire unit consisting of transmitter, power supply and receiver, is mounted on one *Par Metal* chassis. The placement of parts should be done with extreme care if one is to obtain symmetry of controls and a balanced appearance on the panel. Each individual has his own ideas, particularly as to the procedure used in wiring. We find it easier to complete all of the filament circuits before any of the condensers, etc., are wired in.

Referring to the underside view, we see the complete receiver portion at the extreme lower left-hand corner. This is a standard superheterodyne circuit containing Automatic Volume Control and enough audio amplification to permit head-phones to be used when monitoring a station. In order to keep

the unit compact, the tuning condenser is located as indicated with an extension provided to the shaft. The two small shielded coils—namely, the oscillator and the antenna—are located directly above this condenser. To the right, and directly opposite the lower gang, is the mixer tube, Type 6K8. This is followed in order by the first i.f. transformer, the 6K7, the output i.f. transformer, and the 6Q7 a.v.c. audio tube.

A tuning eye, type 6E5, is included in the assembly so that stations may be tuned in accurately, which is essential when these signals are to be used for frequency check. A standard *Amphenol* tuning eye assembly was used, and this is already wired by the manufacturer. A hole is drilled into the chassis so that the long leads may be cabled together and fed to the eye and where they will be short and direct. In some cases it has been found necessary to shield these leads, but in this particular assembly we found it was not needed. (*Please turn the page*)

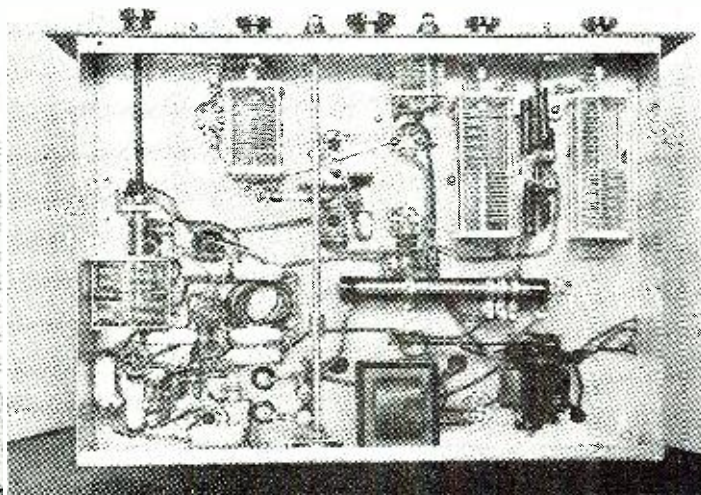
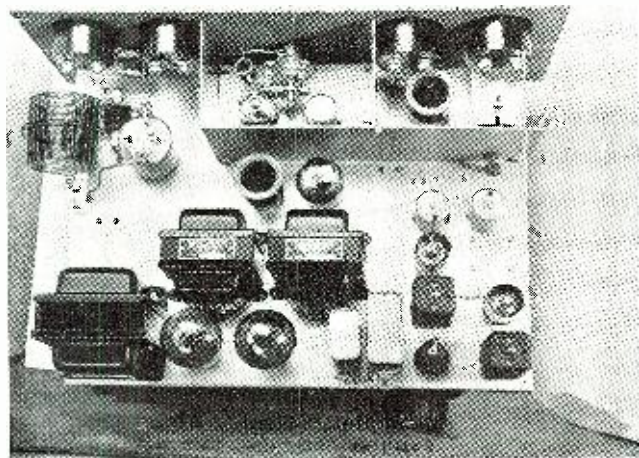

Topside and under-chassis view of the calibrated ECO transmitter.

The audio gain control is mounted by means of a bracket on the back side of the chassis. A length of 1/8" aluminum rod was cut and used as an extension for the shaft. The added work required in locating this control by unconventional means pays dividends from the standpoint of performance inasmuch as the audio signals are kept back away from the r.f. field created around the transmitting components.

A Mallory bias cell is used in the grid circuit of the 6Q7 detector-amplifier to keep hum at a minimum. The builder should be sure that the negative or "shell" part of the bias cell connects to the grid of the tube.

Before proceeding with the construction of the transmitter section, the receiver should be completed and tested following standard procedures used when adjusting and trimming conventional superhets. The use of a signal generator is recommended, particularly for the adjustment of the i.f. transformer, which should be set to 456 kc.

**Transmitter Section**

The use of the new Hammarlund transmitting condensers makes possible a very efficient layout due to the unique design of these units. The

brackets which support the condenser are insulated from both the rotor and stator plates. Furthermore, the condensers are equipped with insulated shafts, which offer two distinct advantages. First, the reduction or elimination of hand-capacity; secondly, that no voltage can appear on the shaft to cause possible shorts or shocks.

All of the variable condensers should be mounted as shown in the illustration. Note that there are two variable condensers used in the oscillator grid tank of the 89 stage. One of these connects to, and is driven by, the large center dial, which is calibrated to

known frequencies. The other is located directly below and under the chassis and is wired in parallel. In addition, another 100 mmf. condenser is shunted across the same circuit, making a total maximum capacity of 300 mmf. This affords a rather high capacity ratio to the grid tank which is highly desirable for maximum stability of the grid circuit.

This fixed condenser should be of the silver-mica variety. These condensers are not subject to capacity change over considerable variation of humidity or (Continued on page 56)

	L <sub>1</sub>	Coil Table		L <sub>3</sub>	L <sub>4</sub>
		L <sub>2</sub>			
80 M Band	79 t. No. 33 enameled close wound tap 15th turn 3/8" diameter form	30 t. No. 22 enameled 1 1/2" long		36 t. No. 22 enameled CT 1 1/2" long	Bud RCL-80
40 M Band		15 t. No. 22 enameled 1 3/4" long		18 t. No. 22 enameled CT 1 1/2" long	Bud RCL-40
20 M Band				9 t. No. 16 enameled CT 1 1/2" long	Bud RCL-20

L<sub>2</sub> coils wound on Hammarlund SWF-5 forms.  
L<sub>3</sub> coils wound on Hammarlund SWF-4 forms.

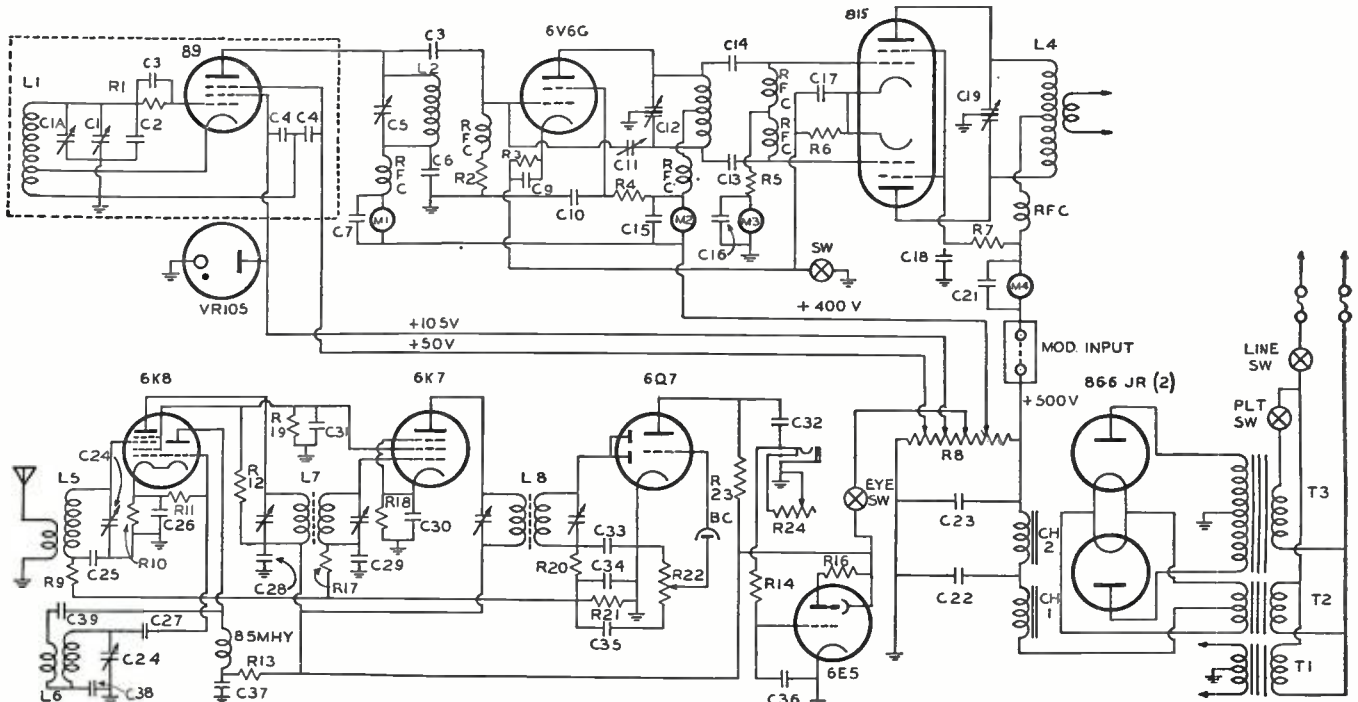

- C<sub>1</sub>A—.00015 mfd.—Hammarlund—NC-150M
- C<sub>1</sub>—.0001 mfd. Hammarlund MC-100M
- C<sub>2</sub>—.0001 mfd. silver-mica Sprague
- C<sub>3</sub>—.00025 mfd. mica Mallory
- C<sub>4</sub>—.003 mfd. mica Mallory
- C<sub>5</sub>—.0001 mfd. Hammarlund HFB-100C
- C<sub>6</sub>—.002 mfd. mica Mallory
- C<sub>7</sub>—.002 mfd. mica Mallory
- C<sub>8</sub>—.0001 mfd. mica Mallory
- C<sub>9</sub>—.01 mfd. 400 v. paper Mallory
- C<sub>10</sub>—.005 mfd. mica Mallory
- C<sub>11</sub>—3-30 mmf. Hammarlund
- C<sub>12</sub>—100-100 mmf. Hammarlund HFBD-100C
- C<sub>13</sub>—.00005 mfd. mica Mallory
- C<sub>14</sub>—.00005 mfd. mica Mallory
- C<sub>15</sub>—.002 mfd. mica Mallory
- C<sub>16</sub>—.002 mfd. mica Mallory
- C<sub>17</sub>—.01 mfd. 600 v. paper Mallory
- C<sub>18</sub>—.002 mfd. mica Mallory
- C<sub>19</sub>—100-100 mmf. Hammarlund HFBD-100C
- C<sub>20</sub>—.002 mfd. mica Mallory
- C<sub>21</sub>—.002 mfd. mica Mallory
- C<sub>22</sub>—2 mfd. 1000 v. oil-filled Aerovox
- C<sub>23</sub>—4 mfd. 1000 v. oil-filled Aerovox
- C<sub>24</sub>—Dual 370 mmf. Meissner
- C<sub>25</sub>—.05 mfd. 400 v. paper Mallory
- C<sub>26</sub>—.05 mfd. 400 v. paper Mallory
- C<sub>27</sub>—.00005 mfd. mica Mallory

- C<sub>28</sub>—.05 mfd. 400 v. paper Mallory
- C<sub>29</sub>—.05 mfd. 400 v. paper Mallory
- C<sub>30</sub>—.05 mfd. 400 v. paper Mallory
- C<sub>31</sub>—.1 mfd. 400 v. paper Mallory
- C<sub>32</sub>—.01 mfd. 400 v. paper Mallory
- C<sub>33</sub>—.0001 mfd. mica Mallory
- C<sub>34</sub>—.0001 mfd. mica Mallory
- C<sub>35</sub>—.01 mfd. 400 v. paper Mallory
- C<sub>36</sub>—.01 mfd. 400 v. paper Mallory
- C<sub>37</sub>—.01 mfd. 400 v. paper Mallory
- C<sub>38</sub>—.004 mfd. mica Mallory
- C<sub>39</sub>—.002 mfd. mica Mallory
- R<sub>1</sub>—100,000 ohms, 1/2 w. Aerovox
- R<sub>2</sub>—35,000 ohms, 1 w. Aerovox
- R<sub>3</sub>—250 ohms, 10 w. Ohmite
- R<sub>4</sub>—25,000 ohms, 1 w. Aerovox
- R<sub>5</sub>—20,000 ohms, 10 w. Ohmite
- R<sub>6</sub>—250 ohms, 10 w. Ohmite
- R<sub>7</sub>—20,000 ohms, 10 w. Ohmite
- R<sub>8</sub>—50,000 ohms, 100 w. adj. Mallory
- R<sub>9</sub>—100,000 ohms, 1/2 w. Aerovox
- R<sub>10</sub>—300 ohms, 1 w. Aerovox
- R<sub>11</sub>—50,000 ohms, 1/2 w. Aerovox
- R<sub>12</sub>—40,000 ohms, 1 w. Aerovox
- R<sub>13</sub>—30,000 ohms, 1 w. Aerovox
- R<sub>14</sub>—200,000 ohms, 1/2 w. Aerovox
- R<sub>15</sub>—500,000 ohms, 1/2 w. Aerovox
- R<sub>16</sub>—1 megohm, 1/2 w. Aerovox

- R<sub>17</sub>—100,000 ohms, 1/2 w. Aerovox
- R<sub>18</sub>—300 ohms, 1 w. Aerovox
- R<sub>19</sub>—40,000 ohms, 1 w. Aerovox
- R<sub>20</sub>—100,000 ohms, 1 w. Aerovox
- R<sub>21</sub>—100,000 ohms, 1/2 w. Aerovox
- R<sub>22</sub>—500,000 ohms pot., Mallory
- R<sub>23</sub>—100,000 ohms, 1 w. Aerovox
- R<sub>24</sub>—250,000 ohms, pot.
- T<sub>1</sub>—6.3 v. fl. trans., Thordarson T-19F97
- T<sub>2</sub>—2.5 v. fl. trans., Thordarson T-19F89
- T<sub>3</sub>—Plate trans., Thordarson T-19P35
- CH<sub>1</sub>—Swinging choke Thordarson T-19C35
- CH<sub>2</sub>—Filter choke, Thordarson T-19C42
- L<sub>3</sub>—Antenna coil, Miller 624
- L<sub>6</sub>—Oscillator coil, Miller 624C
- L<sub>7</sub>—Input IF, Meissner 17-5740
- L<sub>8</sub>—Output IF, Meissner 17-5742
- RFC—2.5 mhy chokes, Millen
- M<sub>1</sub>—Triplet Model 221, 0-75 DCMA
- M<sub>2</sub>—Triplet Model 221, 0-75 DCMA
- M<sub>3</sub>—Triplet Model 221, 0-10 DCMA
- M<sub>4</sub>—Triplet Model 221, 0-250 DCMA
- Cabinet & panel—Par Metal deluxe
- Tubes—RCA—Hytron—Taylor
- Sockets—Millen
- Insulation—Millen
- Coil forms—Hammarlund SWF4—SWF5



by **ROBERT KENDALL**  
Service Manager, Indianapolis, Indiana

### The Morning After

**N**O doubt most of the service men throughout the country shared profitably in the fat little pre-election boom in radio service, which left our small staff with their tongues hanging out, and a suppressed desire to move to the South Seas where radio sets and politicians are fewer. Although at times some of the orators, especially those who had had their feet out of the trough for a few years, seemed about to blow a fuse, the radio receivers bore the brunt nobly, with no more damage than the popping of an occasional by-pass condenser.

This seems to be the ideal time to knock out our monthly chore for *R.N.*, as such rush periods are followed by comparative lulls for some days, broken mostly by the inevitable complaints from those who have spent their first dollar for radio service in five years, and now discover all sorts of queer things "since your man worked on it." But before hoisting out the typewriter we find it necessary to do something about our desk which has accumulated some over-flow of the debris incident to a busy spell. Gazing upon the littered top we recall with some twinges of conscience our earlier exemplary thoughts on cleaning up benches, and glance hastily at the other inmates of the shop to see if the same thought has occurred to them, but we detect no sarcastic smirks from this quarter, as they are engaged in a little house-cleaning of their own—sorting small parts into their proper compartments, fishing up small tools dropped under the bench, and other similar tasks. Anyhow, they probably don't read our stuff, as they hear enough of the boss' opinions during the week without paying two-bits to see them in print.

By a little judicious shoving we find a place for the typewriter, insert the paper and lean back waiting for our jumbled thoughts to come to a focus. Just as we have reached that comfortable state closely resembling suspended animation, which we prefer to think of as concentration, and the unfeeling call dopey, the telephone goes "Bzzz—Zing"; we reach for the receiver muttering "They're Off", and putting on our best business manners begin brightly:

"Super-Snappy Sales and Service!"  
(When your radio's on the bum  
Phone, and we come on the run)

"Yes, madam, this is the manager . . . uh, what? . . . Don't call you madam? Oh, no, of course not, sorry.  
"Yes, Mrs. Fussbudget . . . uh, yes. . . . You say since our man put the little lights back of the dial this morning, your radio is playing too fast? I

see. What is being played? . . . Tiger Rag? Undoubtedly a case of temporary superfluosus thermal agitation of the electrons, as the new bulbs have not quite balanced themselves with your old receiver. Just shut the set off for five minutes and this small matter will adjust itself. Goo-bye."

As we hang up the thought occurs to us, that if she turns into Chopin's Funeral March the next time, it will serve us right for being funny with the trade. "The customer is always right" may be perfectly sound as a business maxim, but cases such as these are always a temptation to depart from the path of good business. Anyhow, this is the only pay-job we have had from Mrs. Fussbudget in eight years—the only other time we heard from her was when she wanted us to bring our ladders and evict a nasty cat from a tree, as the cat was leering through a second-story window at her canary, Dickie Bird, and giving the dear little thing the jitters. Having yanked a cat out of a tree before, we politely declined this one, unless she had a suit of armor around the house. Our suggestion that she buy a parrot that could say "Scat" as a companion and bodyguard for Dickie Bird was not very gratefully received.

In any event we are not greatly concerned about our neighborhood business, as the shop is located in a district the letter-carrier calls a "suitcase neighborhood", on a main traffic artery leading to our profitable clientele a mile or two north of our location. In spite of the low dollar-volume of business in our immediate vicinity, which is counter-balanced by a low shop rent, the location is very satisfactory, as it is conveniently situated for any of our

paying customers who may want to drop in on their way downtown, and is about halfway between our area of trade and the supply houses. The neighborhood business just about pays the rent, which is probably all that should be expected in the service business.

### Service Tips

**W**HILE we hesitate before making the admission, we may plead the enthusiasm of the beginner in our defense, and confess that some years ago, about fourteen to be exact, we were one of the original perpetrators of that now venerable chestnut in the way of service tips, i.e., converting a.f. transformers with a burnt-out primary into impedance couplers, by adding a resistor and coupling condenser. This old grandpappy of service tips has popped up regularly ever since then, to the boredom of all save its latest "discoverer", which may account to some extent for our blase attitude toward service tips in general.

While "service tips" seem to be dear to the hearts of the beginners, the experienced man as a rule views them with more or less tolerant scorn. This is probably due to the fact that too large a proportion of the items usually published are general not "service tips" at all, but simply "I done it" reports. For example, the following caught our eye recently:

"A \_\_\_\_\_ receiver faded at intervals and a stage-by-stage analysis showed the trouble to be caused by condenser C9." As a service tip this is not worth a whoop—as there are probably a half a dozen other condensers in the same receiver that could  
(Continued on page 61)

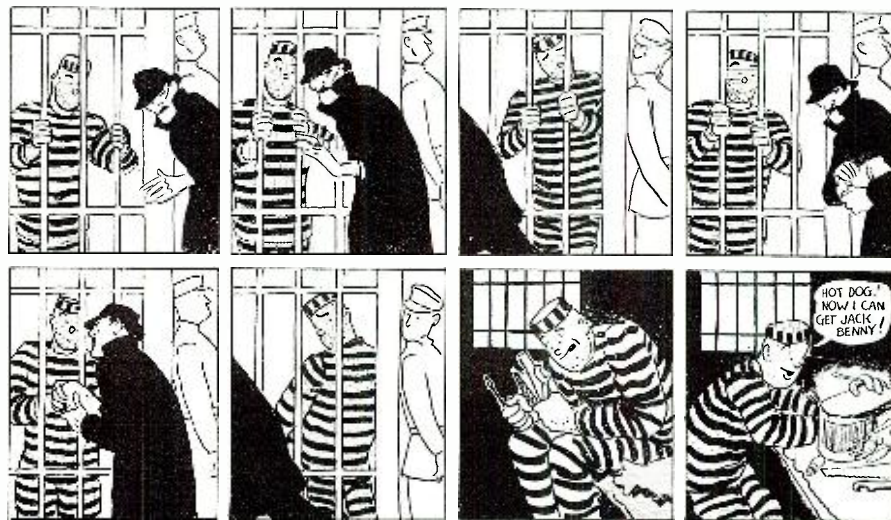

# A De Luxe FREQUENCY STANDARD

by **C. G. SIMS & C. B. LESTER**  
Engineers, WHOP, Paducah, Ky.

***Describing the construction and operation of a secondary frequency standard which was approved by the F.C.C. for use at Station WHOP.***



ALMOST everyone connected with a radio has, at one time or another, wished for a signal of known frequency that would meet precision requirements, or a means of setting some piece of apparatus at a predetermined frequency. This rig will meet these two requirements with absolute accuracy, and besides these two primary duties, will enable the operator to ascertain, within limits of human accuracy, the frequency of an unknown incoming signal.

As a means of setting frequency, or of measuring signals that are even multiples of ten kc., this unit is entirely approved by the FCC, as evidenced by their allowing station WHOP to open with nothing but this apparatus as a frequency determining monitor. WHOP was measured twice while waiting for RCA to ship a frequency monitor, and at no time did the deviation from 1,200 kc. exceed 2 cycles per second—and that's precision in any man's language. These measurements were not made on a special measurement schedule either, but were made in the early hours of the morning while the usual adjustments were being made on the new transmitter, so it had all the chances it could have to get off frequency. Yet, when the transmitter was set for its measurement, it wasn't off enough to tell it. Those two cycles deviation could have been caused by a number of things, but it is believed that at the time the crystal was set to 1,200, that it could not have been more than a half cycle off frequency.

But to get down to facts, the instrument described is a crystal controlled multivibrator with several practical improvements and innovations that make for easier operating technique. While it is not claimed that it's the best in the world by any means, it will hold its own with any other similar unit costing twice as much.

## Theory and Operation

The multivibrator is not as widely known and used as it might be, and that's very probable because sometimes inexperienced operators are bewildered by its operation. However, brief summary of the theory that lies behind its operation will clear up all hazy ideas concerning it.

In the first place, a multivibrator is nothing more than a modified "relaxation" or Franklin oscillator consisting of two triodes with their elements connected so as to provide continuous oscillation between the two tubes. In other words, as shown in the skeleton diagram there are two tubes, with the plate of No. 1 hooked to the grid of tube No. 2, and then tube No. 2 has its output run back into the input circuit of tube No. 1. Because of the 180° phase shift that occurs in a tube, the signal is always in exactly the right phase and potential to sustain oscillations.

Thus, for example, say some disturbance in the grid circuit of tube No. 1 caused a small positive signal voltage to appear on its grid. It would be amplified by the tube and its phase reversed and transmitted to tube No. 2 greatly amplified and in a reversed negative potential. As a negative signal, it would be in turn amplified by tube No. 2 and its phase again reversed, and the signal, again amplified

The entire frequency-checking set-up.

would reappear on the grid on the first tube in an enlarged condition and again as a positive voltage, thus supplying a continuous oscillation.

As in the original Franklin oscillator, the oscillatory frequency is mainly dependent upon the values of the grid resistors and the time delay effected by the coupling condensers. With the values shown in the main diagram, it becomes very possible to construct an oscillator that will sustain r.f. oscillations at the very low frequency of 10 kc. per second.

But to get back to the theory of operation. The output of a multivibrator type oscillator is very rich in harmonics; useful output appearing at 10 kc. intervals (in the case of a 10 kc. oscillator) up as high as the 56 mc. amateur band. "Well," the question is often asked, "why use all the rest of that junk if two triodes will get 10 kc. output up to five meters?"

That's fine. It would work; but the output of the multivibrator without any controlling signal is very mushy and output is liable to appear at points that are not by any means even multiples of ten. That's where the controlling voltage comes in. The most outstanding characteristic of the multivibrator type of oscillator is its ability to be "locked in" by a small injection of controlling signal voltage. Thus, by applying a control signal of 100 kc. to the 10 kc. output of the multivibrator it is possible to "lock" the multivibrator "in" at exactly 10 kc., an even division of 100 kc., and thus the idea that a multivibrator is a dividing unit. While in practice it really is the same as a frequency inverter, or divider, in theory actually it is the output of the multivibrator itself that provides the 10 kc. output, and not the controlling oscillator.

So, by utilizing a 100 kc. crystal oscillator with a great degree of stability, it is possible to have a multivibrator unit that will provide output at its own fundamental frequency, but yet have the same degree of stability as the controlling signal, or, in this case, have the same degree of stability as exhibited by the crystal oscillator.

**Description of Circuit**

By referring to the diagram and pictures, it may be seen that the unit described consists of four tubes. Of these four, only three are actually used in the frequency standard circuit. The type 80 is used as a rectifier to supply power to the other three.

The tube on the extreme left of the chassis is the 6J7 crystal oscillator. The circuit is an exact copy of the circuit recommended by the *Bliley Mfg. Co.* for use with their SOC-100, 100 kc. bar. We take no credit for this circuit—we figured that the manufacturer knew more about his equipment than we did, so we merely copied, to the letter, his outline. We have never been sorry.

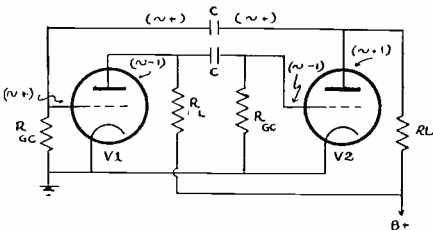

Theory of operation.

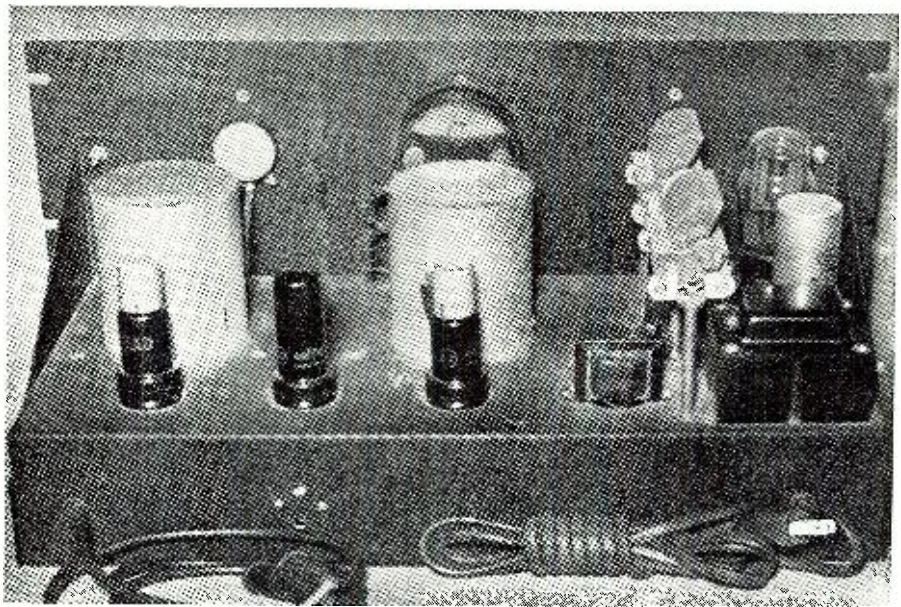

Back of the panel view of the secondary frequency standard.

Basic circuit is this—a 6J7 with crystal controlled grid circuit and untuned or aperiodic plate tank. At first, we contemplated controlling the voltages to the elements of this tube, but its stability was so high without it, we didn't think it would be worth the extra time and money required to utilize this feature. With the tuned circuit that the big two-gang condenser and choke sets up about the crystal, the crystal stability is such that under nor-

mal conditions, it never varies more than 2 cps from zero beat with WWV on 5,000 kc., and since that is the 50th harmonic of the 100 kc. oscillator, that means that the oscillator is not more than 1/25th of a cycle off on its fundamental frequency. And that's accuracy.

So far the circuit and outline has been entirely conventional, but it's not all that way. As outlined before, this instrument consists of a crystal oscil-

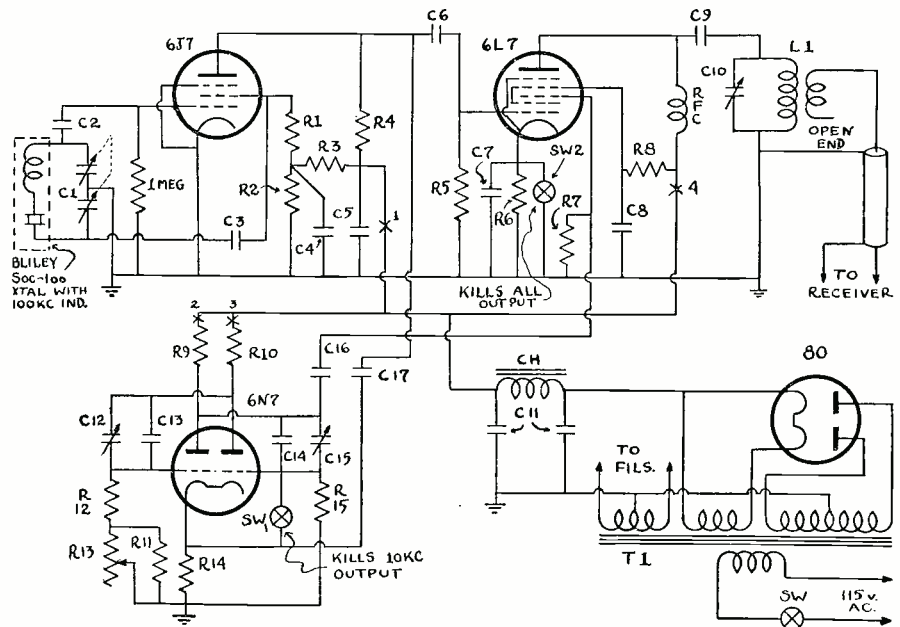

- R<sub>1</sub>—500,000 ohms, 1 w. IRC
- R<sub>2</sub>—100,000 ohms, 1 w. IRC
- R<sub>3</sub>—150,000 ohms, 1 w. IRC
- R<sub>4</sub>—500,000 ohms, 1 w. IRC
- R<sub>5</sub>—100,000 ohms, 1/2 w. IRC
- R<sub>6</sub>—25,000 ohms, 1 w. IRC
- R<sub>7</sub>—50,000 ohms, 1/2 w. IRC
- R<sub>8</sub>—15,000 ohms, 1 w. IRC
- R<sub>9</sub>—250,000 ohms, 1 w. IRC
- R<sub>10</sub>—250,000 ohms, 1 w. IRC
- R<sub>11</sub>—50,000 ohms, 1/2 w. IRC
- R<sub>12</sub>—20,000 ohms, 1/2 w. IRC
- R<sub>13</sub>—15,000 ohms pot. Centralab
- R<sub>14</sub>—300 ohms, 1/2 w. IRC
- R<sub>15</sub>—30,000 ohms, 1/2 w. IRC
- T<sub>1</sub>—Plate & fil. trans., Thordarson T-13R11
- CH—Filter choke, Thordarson T-13C26
- Crystal—Bliley SOC-100 "With inductance"
- C<sub>1</sub>—350-350 mmf. dual Hammarlund
- C<sub>2</sub>—.01 mfd. mica Sprague

- C<sub>3</sub>—.01 mfd. mica Sprague
- C<sub>4</sub>—.05 mfd. mica Sprague
- C<sub>5</sub>—.1 mfd. 400 v. paper Sprague
- C<sub>6</sub>—.01 mfd. mica Sprague
- C<sub>7</sub>—.05 mfd. 400 v. paper Sprague
- C<sub>8</sub>—.1 mfd. 400 v. paper Sprague
- C<sub>9</sub>—.002 mfd. mica Sprague
- C<sub>10</sub>—140 mmf. Hammarlund MC-140 M
- C<sub>11</sub>—Dual 8 mfd. 450 v. electro. Sprague
- C<sub>12</sub>—.001 mfd. silver mica Sprague
- C<sub>13</sub>—30 mmf. ceramic trimmer
- C<sub>14</sub>—.001 mfd. silver mica Sprague
- C<sub>15</sub>—30 mmf. ceramic trimmer
- C<sub>16</sub>—.002 mfd. mica Sprague
- C<sub>17</sub>—.000025 mfd. mica Sprague
- L<sub>1</sub>—130 t. No. 30 enameled (550-1200 KC)
- 70 t. No. 22 enameled (1200-3300 KC)
- 22 t. No. 22 enameled (3300-7500 KC)
- 11 t. No. enameled (7500-15,000 KC)
- 2 t. No. 14 enameled (56 mc)

lator, multivibrator, rectifier, and an extra tube that just "sits in" for several operations. Since we've rather lengthily discussed the multivibrator, and the crystal is conventional, suppose we go to something rather odd. This unit is like some people we know—"It's got something nobody else had got!"

You've heard, no doubt, of dual purpose tubes and triple purpose tubes maybe,—but this is probably the first tube you ever saw that manages to perform four distinct and unrelated functions and at the same time keep its mind on its business.

The 6L7 is mounted on the right side of the chassis, and is wired in a circuit that might seem ordinary at first inspection. However, we'll explain the way it works as we come to it. For operation number one, and probably the most important, it acts as an electronic coupler, or mixer, for the two sets of voltages, i.e., that from the 100 kc. oscillator and from the multivibrator. Thus, the coupling between these two stages may be varied to any extent without affecting the operating conditions or loading on either stage. This idea isn't new; as a matter of fact, it's being used in most of the receivers made today—but that's one thing that makes our outfit stand out from others. It's not the kind of circuits we use, it's the use and the way they perform under their operating conditions. Half of the receivers in the country use this type of coupling in the mixer stage, but there's *not* half of one percent of the multivibrators use it, or anything like it.

Now here's number two. Besides providing electron coupling between the two oscillators, it provides for independent coupling to the external circuit. There is absolutely no "pulling effect" when varying the coupling to an external load, and here's why.

The 6L7 is acting as a class "A" r.f. amplifier, and as such, should require no driving power—nothing but a voltage swing. Now working backwards, if the 6L7 needs no driving power, there is no power taken from the plate of the 6J7 oscillator, and from there, if there is no power taken from its plate, there is no power, or current, taken through the crystal. Of course, practically this is an impossibility, but it approaches the ideal point of operation and is almost absolutely perfect.

If there is no variation on the crystal oscillator, and the 6L7 is operating class "A," then no variation in the output coupling can affect the output from the frequency standard unit because the multivibrator unit's output is dependent upon the stability of the crystal oscillator. And so there could not possibly be any "pulling."

That's two of the functions of the 6L7. The third is to provide a means of amplifying the combined output of the two oscillators. Just try to get any appreciable output from a conventional multivibrator unit at 5 meters and you'll appreciate this added convenience. We stated in the section under "Theory" that the output of the multivibrator is rich in harmonics. That's an understatement,—it fairly runs over with them, and with the 6L7 as a harmonic amplifier there is almost no limit except circuit design and tube insulation to the extent of the frequency of operation.

(Continued on page 51)

# AVIATION RADIO

by CHARLES J. SCHAUERS

**D**URING the past two months, many questions have been received pertinent to the selection of radio schools that specialize in aviation radio instruction; and judging from the letters received, many of our readers are contemplating the study of aviation radio. Because most of the questions received, were more or less of the same nature, a generalized answer will be given this month.

The prospective student of an aviation radio course should choose the school "specializing" in this instruction, with a keen sense of circumspection.

Aviation radio training is, in every sense, a specialized instruction that must be administered by those who are competent and experienced in this specific line of endeavor; and furthermore, it is fully realized by those now engaged in aviation radio work, that the basic radio theories, etc., must be consummated by the average student before specialized study may be considered. The necessity is of course obvious.

The study of aviation radio doesn't necessarily mean that text books are consulted; a few lectures attended; two or three pieces of aviation radio equipment examined and analyzed, but it does mean that the student must obtain, in addition to his regular training, as much actual experience as schooling can offer, outside of direct employment. This experience is not to be obtained, however, by sacrificing systematic instruction.

The method, "instruction while working," usually used by some of the larger aviation corporations, is generally employed because the corporation heads feel that the embryo radioman is worthy of consideration, and because they feel too, that once their methods are learned thoroughly, that the education received by the student will prove an eventual asset not only to him, but to them, in terms of returned efficiency.

Working as a "graduate student radioman" after completing the usual aviation radio course solves the problem of experience. However, "there's more than one way to string up an antenna!"

A word about schools: Any school purporting to teach aviation radio must possess not only trained instructors and employ modern teaching methods, but it must also have on hand, various types of equipment for practical training-work, if it is to turn out graduates who must have the knowledge necessary to survive the keen competition, and to cope with modern problems and modern methods.

Every school, regardless of size, not only desires graduate students who have "made good," but it also wants its students to make it known indirectly, that its instruction was the "stepping stone" to the graduate's success. This is the reason why certain schools refer the prospective student to one of their graduates for "enlightenment."

There are many schools today, who advertise, "aviation radio" instruction, and the unwary student usually falls into a maze of "mis-instruction." By this, I mean, that some schools advertise aviation radio courses when all they give, in part, is a course either in aircraft radio maintenance or ground radio station operation; and sometimes these aren't usually covered fully.

A general aviation radio course embodies much, and many people do not seem to realize that the aviation radio field is a large one; and usually think of it as another "branch." This isn't the case, because in aviation radio we find classified: Airlines radio operation; aircraft radio operation; aircraft radio maintenance and installation; aircraft and ground radio equipment design; aviation radio station ground maintenance and installation; traffic radio control operation; beacon maintenance and installation; radio-instrument landing and navigational aid systems installation and maintenance; and last but not least, aviation radio sales.

Teletype operation, maintenance, and in-

stallation; sensitive instrument installation, repair, and construction; and electrical and ignition test, installation and maintenance, are but a few "sub-branches" that the aviation radioman should have some knowledge of. Too, there are factory jobs that have not been truly considered.

The foregoing list gives the reader an approximate idea of what aviation radio embodies.

Now, if these specific jobs are to be performed in a manner that will not only reflect credit on the performer as well as the school, it would be logical to assume the contention that the school in most cases, would have to be the "prime mover" toward this end.

Good instructors are at a premium at present, and it is quite impossible to find one who is able to teach the subject matter of each of the branches listed above, in a commendable manner. However, it is possible to cover the subjects outlined, in a superficial manner, utilizing one instructor; but then we sacrifice thoroughness which is absolutely essential in any phase of radio. Therefore, when choosing schools, make certain that experienced instructors are available; that, the subject matter of the specific course you have chosen is thoroughly covered; that, adequate equipment has been provided, and by comparison, that you are getting your money's worth! Too, first ascertain what course would fit your interests, your time, and your adaptability.

The study of extensions courses (correspondence) is to be encouraged, but the average individual's progress when taking an extension course is controlled by the student himself, and not by a class or class instructor. Time is the elemental factor here.

Upon receipt of a self-addressed, stamped envelope, a list will be sent to any prospective student which contains added information that will prove valuable to you in the choice of a school for training in any phase of aviation radio.

**A** NEW radio range beacon which makes possible air navigation by radio without restriction to predetermined fixed courses between cities, has been developed in the RCA research laboratories at Camden.

Dr. David G. C. Luck described the new

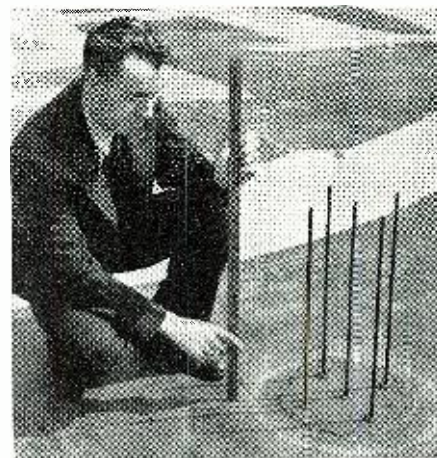

development to 200 engineers attending a meeting of the Philadelphia Section of the Institute of Radio Engineers in the auditorium of the RCA Manufacturing Company in Camden. He explained that the new device tells a pilot his exact direction at all times with relation to the radio beacon transmitter at his destination. If the plane deviates from its predetermined route, the drift is indicated on a dial on the instrument panel. The dial, furthermore, indicates a new route to the original destination as

(Continued on page 63)

# Serviceman's Experiences

by LEE SHELDON

Chicago, Illinois

## How to handle Junior, when he thinks that he's a "Steinmetz"!

**W**HEN the call to service a Zenith 52 came in, a woman had spoken on the 'phone, so I was surprised when a young man opened the door. He was about 15 years old, and I knew instinctively there was something about him I wouldn't like. But I didn't let my personal feelings interfere with my routine greeting.

"Mrs. Sandborn?" I asked. "Salutary Sales & Service."

"I'm her nephew," he replied.

"Did your aunt call for—" I began, stepping inside and walking toward the living-room.

"This way," he ordered, pointing to the kitchen. "I dropped in just after she 'phoned," he explained, "and took the set out of the cabinet to give it a once-over."

The three pieces of the chassis were lying on the drain-board of the sink. The tuning chassis was upside-down, and the cover had been removed. I noticed, with an uncomfortable feeling, that some of the soldered connections looked new. So that was it—an amateur expert!

"Who's been working on the set?" I asked, hoisting my hackles.

He was quick to sense my feeling.

"I have. I'm a radioman, myself," he said. "Look—I'll show you."

He pulled a billfold from his pocket and showed me an identification card. It was one of those "To Whom It May Disconcert" affairs, announcing, in ornate type, that bearer Homer Jones was enrolled at some backwoods radio school.

"Ah, yes!" I said, as paternally as possible, "we all have to start some way!"

"Whatya mean, start?" Homer said. "I've finished! I'm a graduate!"

"Congratulations," I said dully, wishing I knew exactly how much radio Homer really knew, so I could go ahead with my work. "Well—what did you find out about the set?"

"I practically had it repaired," he boasted, "except that it wouldn't play."

"That," I said sarcastically, sensing an advantage, "is a characteristic which most professionals classify as unfavorable."

He gritted his little teeth—bless him!—and replied:

"You might as well look at it, as long as you're here. But Aunt Clara says I'm to watch you!"

I began to work on the set. He watched me closely. You know how it is when two unfriendly radio men work on the same set—it's like two women peeling one potato, or two hens trying to hatch the same batch of eggs. It's very embarrassing. I firmly believe that one of the inalienable rights of a repairman is to be alone with his soul while he chases trouble.

"What," the dear young lad asked, "is the value of this resistor?"

It was colored yellow all over, and I couldn't trace the leads quickly, so I was forced to confess I didn't know.

"How many VU output has a job like this?" he asked.

Up until that moment, I had never really appreciated Hanley Stafford's feelings toward Baby Snooks. I've been studying, off and on, the TU, the DB, and the VU; but things like that take time, and there's no necessity to rush them because they don't come up in the average call.

"Who cares what output the set has," I snarled, "as long as it plays? It either works, or it doesn't!"

"I thought so," remarked Satan's gift to servicing. "Oh, Aunt Clara!"

Mrs. Sandborn appeared; we nodded mechanically, and the boy got in his dirty work.

"This fellow," he said, designating me with his left thumb, "doesn't know radio. He doesn't know what parts are in the set, and he has no idea how it sounds after it's fixed."

"Well, now, Homer," Aunt Clara said, pleasantly, "give the man a little time. After all, he's been here only fifteen minutes."

"Yeah," the boy replied, "and I'd have had it repaired by now if he hadn't interrupted me!"

"Look, lady," I broke in, "I refuse to be insulted. I have my professional pride, you know. Either you get rid of this stymied Steinmetz, or I drop the job!"

Her manner changed, and she walked to the hall door.

"The choice has been yours," she said, coldly. "You may leave—and take your professional pride with you."

When I got back to the shop, Al couldn't see my point of view.

"You were completely wrong," he declared. "If you'd have flattered the fellow instead of antagonizing him, he'd probably have sold his aunt the repair job for you."

"Don't gimme that," I shot back. "These experts are poison. Even if I'd kept him quiet long enough to analyze the set, he'd probably have tried to hammer my price down, just to show how smart he was!"

"Not if you handled him right," Al insisted. "You could have said some-

thing like 'The set needs a new such-and-such, and you know what a tough job it is to get a good one, and how long it takes to install it,' and he would have agreed whether or not he knew what you were talking about."

"But a fellow like that knows just enough radio to confuse me," I said. "How can a person work with a wise guy hanging over his shoulder?"

"In an extreme case," Al explained, "you might be justified in bringing matters to a showdown by telling him you would rent out your toolbag at three dollars an hour. If he knew the business—which is unlikely—he might take the challenge, and you'd have the three bucks. If he didn't, you'd have the upper hand. With your method, you have nothing but ill will to show for the call, and you still haven't learned how much radio Homer really knows. I'll bet a competitor, not the boy, finally repairs that Zenith!"

"You talk a nice repair job," I jabbed back, "but I'll bet you'd feel differently if you were trying to concentrate while Homer's hostile breath streamed down your back. Personally, I believe it would be better to refuse all calls for service from families which contain an expert."

"I know how you feel," Al admitted, "but don't forget that all experts are different, and that you shouldn't try to lay down general rules about them."

The next day, I picked up three addresses from the desk. I answered the first two, but when I read the name on the third, I drove back to the shop.

"Hey, Al," I shouted, "don't you know who this 'Mr. Clive' is?"

"Sure," my partner replied. "He's Wentworth Clive, Chief Engineer of Xerxes Radio. Why?"

"Don't ask me to face that fellow and sell him any radio repairs," I said. "He's the fellow who put the first electron into motion!"

"What if he did?" Al asked. "Does his experience scare you? You don't think he called us just to make fun of you, do you?"

"Listen, Al," I demanded, "Clive is one of the five best radio engineers the world has ever seen. Remember that paper of Einstein's that only 12

(Continued on page 48)

### SOMETIMES WE FEEL LIKE THAT!



# Build Your Own RECORDING STUDIO

## -FREQUENCY RESPONSE-

by **OLIVER READ**

Technical Editor, RADIO NEWS

The author discussed how to make frequency test runs, and how to interpret the resulting pattern with the aid of a light. A most important subject for recordists.

### Part 3.

THE first two articles of this series took the prospective recordist through the early stages of constructing a recording console, the selection of equipment, the use of both AM and FM tuners for "off the air" programs, and a general discussion of related equipment. The recording amplifier was described and its features for getting maximum flexibility stressed. Those who are seriously following this series from a technical viewpoint, and there are many, will do well to consider this means for the study of their equipment. We had intended to get into studio recording, etc., in this installment, but since many a record failure may be offset by the reader first learning more about his own particular equipment we altered our course.

There are so many variables in re-

recording equipment that each combination must be studied in order to determine its proficiency. Little information has been made available on different methods used to make these tests, and we feel that in our own studio that we have been able to make adjustments to our equipment that have improved results many times over, and that the time spent in making these tests has pointed out just what can be done to improve on the conventional hit-and-miss methods used by the average recordist. It is amazing what faults can be revealed when the following tests are run.

After making adjustments to offset these discrepancies, we may proceed, with a full understanding as to the capabilities of our equipment.

#### Frequency Measurements

There are several means used for de-

termining the response of cutters and associated equipment. One of the most accurate is the use of an audio oscillator, vacuum-tube-voltmeter and the regular output level meter on the recorder amplifier. With this combination we can obtain definite patterns on the discs that will show exactly what is taking place. A disc that has been cut *properly* with a sharp stylus, preferably sapphire, will have grooves which are *shiny* in appearance and capable of reflecting light rays when placed in proper position with respect to the eye of the observer. Unfortunately, much detail is lost in reproducing the original photos, but they illustrate the effects.

An improperly cut disc, one cut with a dull stylus, cannot assume this shiny character and is not suited to the study and analysis of frequency response. The setup used to obtain the following photos makes use of a single light-source. We used a No. 2 photoflood lamp without reflector and a standard make of 5"x7" camera. Exposure data is not available.

The electronic end of the setup consists of the CB Audio Oscillator, shown to the rear of the *Speakophone* table, a VTVM to keep the audio output of the oscillator at a fixed level, the amplifier described in the first installments of this series, the db meter to observe the cutting level at the cutting head, and the recording table and a disc (Audio Devices make).

The records are all at a standstill in the illustrations and all except the one shown in Fig. 5 were made from the same general position of the camera except for distance.

The most important tests for the layman deal with the determination of cutter response as it is called upon to modulate the various frequencies on the disc. If these are lacking or improperly cut, or if too high or too low a cutting level is used, he may, with this setup, determine where the system is lacking and take proper steps for correction where needed. The procedure may be used on any type of recorder, whether it be a simple home type portable, or the more elaborate ones shown in this series of articles.

The apparatus used to make the test runs; a recorder and audio oscillator.





### Interpretation of Light Patterns.

When grooves have been cut properly on a test record, and are observed under reflected light, as shown by the photographs, the response may be determined as well as the actual cutter capabilities. These patterns show accurately what is taking place in the entire equipment and this includes the amplifier, tuner or mike, the cutting head, stylus and the play back pickup.

Now, let us analyze the first test record, Fig. 1. This disc was cut at  $33\frac{1}{3}$  r.p.m. on a  $1\frac{1}{4}$  inch disc—inside-to-outside. The minimum diameter was 5". A +18 db. cutting level was maintained over the entire frequency range and the controls on the amplifier were set so that in audio response is essentially flat from approximately 20 cps. to 15,000 cps. Note that the absence of equalization has a definite effect on the cutting capabilities.

The frequencies appearing on the disc, from the right (hub) to left on the illustration are as follows: 1000, 2000, 3000, 4000, 5000, 6000, 7000, 8000, 9000, 10000, 11000, 12000 cps. and then in the same steps in reverse back to 1000 cps. and then on through the lower frequencies of 900, 800, 700, 600, 500, 400, 200, 100, 50 and 25 cps. The small light portions between each series of grooves that were cut, indicate the normal surface noise, or unmodulated grooves. A complete story has been told on the finished disc—and the interpretation follows. The middle register, from 1000 to 7000 cps. shows a rather even groove modulation, as indicated by the width of the cut lines. The response begins to taper off at 7000 cps. and we still observe that cutting is taking place up to over 10000 cps. Then the surface noise level almost equals the modulated level.

From the above observation it is apparent that we must *boost* the frequencies *above* 7000 cps. by several decibels in order that they be modulated on the disc, if the finished recording is to be brilliant in character, and if we expect to be able to hear these frequencies above the surface-noise level.

The effects of boosting may be observed in Figs. 2 and 3. Returning once more to the analysis of Fig. 1, we find that we have cut the disc properly from the 7000 cps. range down to 50 cps. At 25 cps. we can see a slight dropping off in response, but this is still above the surface noise by the amount of 2 or 3 db. The pattern on the outside of the disc is 400 cycles cut at a constant reference level (in this case) of +14 db.

If it were possible to compensate for the loss of the higher frequencies, we could increase the width of the pattern at those frequencies and this would be done by increasing the cutting level (volume) over the range that requires this treatment. This may be done by proper use of the bass and treble equalizers (tone controls).

The amplifier has been designed to include circuits that are capable of four distinct response characteristics, either to boost or attenuate the high frequencies, and to either boost or attenuate the low frequencies. Moreover, many combinations are possible over the entire range so that we have plenty of latitude for adjusting the response of the amplifier to meet practically any condition.

Now we shall make another test recording to determine how far we can boost the high frequencies without getting into trouble from distortion, etc. Fig. 2 illustrates the effect. Remember that *the widest patterns are cut at the highest level*, and *the narrowest grooves are cut at the lowest level*. Starting at the right side of the illustration we find our first frequency, 10000 cycles in this case. This disc was started at a minimum diameter of 6" in order to attain more velocity (record speed) in order that the high frequencies could be cut.

The treble control on the amplifier was set for an increase at 6000 cycles of +8 db. above normal. Thus, volume was increased auto- (*Please turn the page*)

Right: Figure 4; below, figure 5.

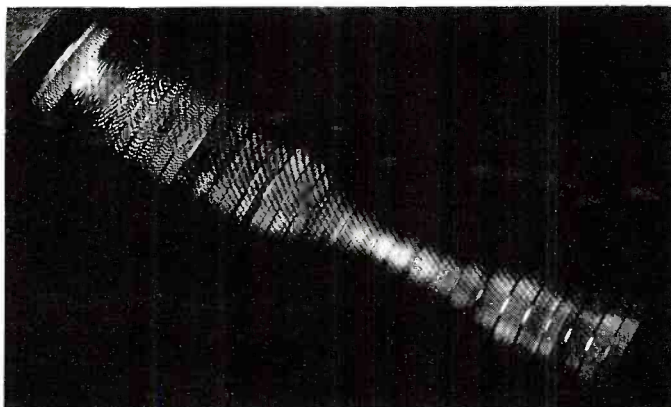

Figure 1.

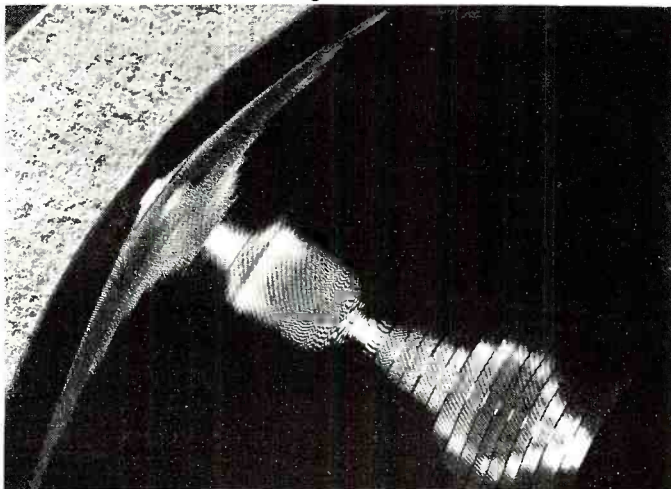

Figure 2.

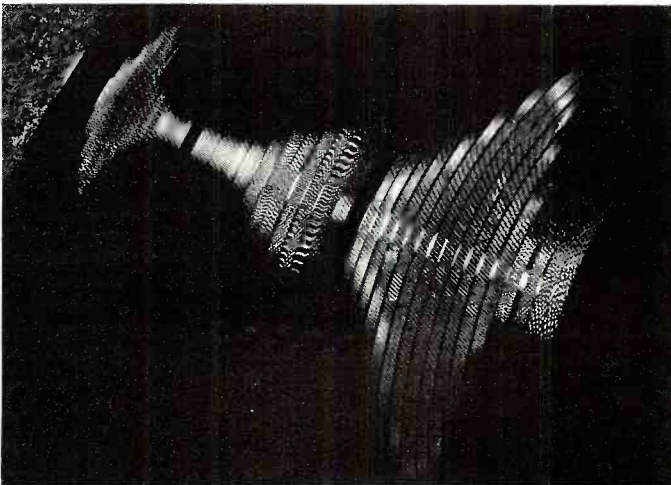
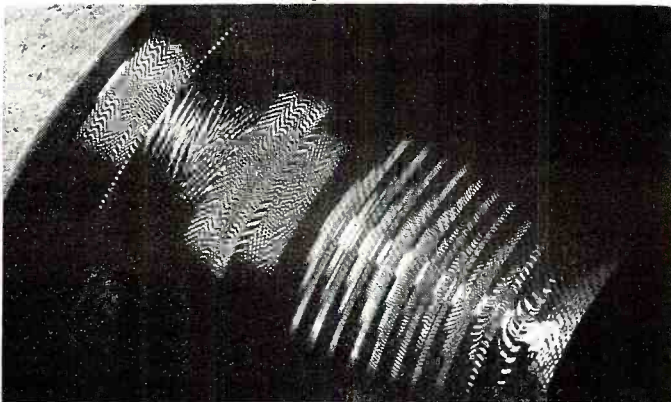
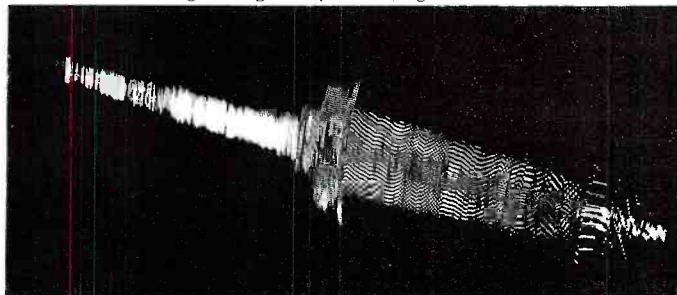

Figure 3.



matically at this frequency so that every time a note of 7000 cycles appeared at the amplifier, it would be boosted by that amount. The bass control was left at normal response. The audio oscillator output was kept to a constant level while the cutting took place.

Analysis of Fig. 2 shows that there is a definite peak both at 7000 cycles and 6000 cycles. In fact the two are nearly cut at the same amplitude. Counting the groove cuts from the inside-out, right to left, we find the following frequencies: 10000, 9000, 8000, 7000, 6000, 5000, 4000, 3000, 2000, 1000, 900, 800, 700, 500, 300, 100 and 50. Note that the frequencies below 300 cycles fall off rapidly in amplitude. This is necessary in cutting "Constant Velocity" records and is known as the "turn-over" or point where the characteristics are altered in the equipment so that the bass frequencies will not overcut the groove walls, due to the greater stylus displacement. However—these low notes will still be reproduced satisfactorily and the bass control may be set to effect a boost when the record is played back.

The second portion of the disc, from the narrowest part out, is cut with a rising frequency note in linear steps from 50 cps. to 15000 cps. Note that the response is very uniform from about 100 cps. to well over 7000 cps. This is considered very satisfactory from the listeners point of view. However we can still improve matters to increase this response to include a greater audio range as we shall see later.

The third portion has been cut with a 1000 cycle note in steps of 2 db. from +12 to +26 db. and returning in 2 db. steps to +12 db. This illustrates the effect of cutting level. Note the wide

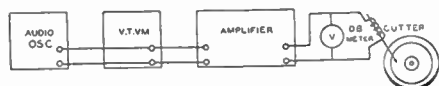

Block diagram of test setup.

pattern when high levels are reached. In fact, we actually overcut the record in order to illustrate the point. Now if we play back the test record and observe where distortion is heard, we have an accurate guide for the proper cutting level to use on our own particular equipment by counting these steps.

Other frequencies may be observed under the same conditions, and the patterns will give the same indications. We may make notes as we progress, in fact, this is essential for identifying the patterns.

Fig. 3 illustrates a series of three tests. First is a frequency run from 50 to 12000 cycles, cut at a level of +18 db. The treble control at the amplifier was set to full boost at 4000 cycles and the bass control to full boost. The steps are as follows: 50, 100, 250, 500, 1000, 2000, 3000, 4000, 5000, 6000, 7000, 8000, 9000, 10000, 11000, 12000 cycles.

Observation discloses that the frequencies of 50, 100, 250 and 500 cycles are cut at a uniform amplitude. There is an increase of approximately 2 db. at 1000 cycles and from there up to 5000 we observe steps of better than 2 db. for each successive frequency. The middle register has been boosted con-

(Continued on page 62)



**Manufacturer's Specifications**  
**Make:** RCA.  
**Model:** 73-A.  
**Manufactured by:** RCA Manufacturing Co., Camden, N. J.  
**Motors:** Dual—Constant Speed.  
**Turntable:** 16" transcription type—extra weighted.  
**Cutting Head:** MI-4887 DeLuxe Recorder head.  
**Pickup:** Not included. Standard mounting available.  
**Turntable Speeds:** 33 $\frac{1}{3}$  and 78 r.p.m.  
**Grooving:** Choice of 96, 112, 120, 136, or 154. (Outside-in or Inside-out.)  
**Drive:** Pulley and belt system.  
**Microscope:** Illuminated (adjustable).

#### Introduction

The RCA Type 73-A DeLuxe Recorder and Turntable consists of an MI-4887 Recorder Head and an MI-4915 Turntable Assembly which includes a dual motor and drive mechanism, a record plate, recording equipment, a microscope and microscope lamp, a lamp for illuminating the whole or any part of the assembly, and a suction nozzle (less the suction generating and hose connecting equipment) for removing acetate shavings from the record. Provision is made for mounting a pickup and tonearm, MI-4875-A, onto the turntable. The Type 73-A DeLuxe Recorder will record 96, 112, 120, 136, or 154 grooves per inch at 78 or 33 $\frac{1}{3}$  r.p.m., either "inside-out" or "outside-in" without changing feed screws.

The recommended pickup and tonearm, and suction equipment, which are not included with the MI-4915 DeLuxe Recorder are explained in following paragraphs under the heading "DESCRIPTION." A pickup and tonearm are required to play back a recording. The DeLuxe Recorder can be operated without the suction equipment, but one is highly desirable if outside-in recordings are to be made.



#### Description

The essential parts of the DeLuxe Recorder consist of two separate motors and turntable drive wheels, both controlled by one "on-off" switch; and both drive mechanisms controlled by one speed changeover switch. It is designed so that when the motor switch is turned to "off" a brake is automatically applied to the rim of the turntable, bringing it quickly to a stop.

The recording equipment driving mechanism consists of a pulley and belt system between the driving shaft and turntable spindle. The drive shaft pulley is fastened to the drive shaft through a built-in clutch. Mounted on the drive shaft (above the turntable level) is a friction wheel disc assembly which in turn drives the flange on the end

of the feedscrew assembly. The friction wheel disc assembly is mounted on a rack and may be moved by means of a pinion gear and knob, up and down over the entire diameter of the feed screw flange. A pointer and scale on the outside of the housing for the friction wheel disc assembly indicates the proper setting for the required number of grooves per inch for either "inside-out" or "outside-in" recording. The release lever arm located just above the knob should be lifted to disengage the friction wheel disc assembly when changing feed screw speeds or direction of cut. The friction wheel disc assembly automatically disengages from the drive flange on the end of the feed screw assembly when the carriage assembly is rotated to the rest position, and automatically engages when the carriage is released from the rest position.

On the turntable side of the friction wheel disc assembly housing is mounted a screw and locknut for controlling the amount of pressure on the friction disc drive. This is adjusted at the factory for proper tension. If it should be necessary to readjust the tension should be increased only to the point where no slippage occurs. By pulling the small knob straight away from the casting the locknut may be turned to make adjustment. When released, the knurled nut should fit over the small pin in the casting, locking it in place.

The feed screw is made of stainless steel, and its threads are so designed that the recorder head carriage may be fed either "inside-out" or "outside-in" without changing feed screws. The driving surface of the thread is designed steep enough so that there is no tendency to lift the feed lever out of mesh when under load. There is a small flat on the crests of the threads, in order to support the carriage assembly when it is moved laterally with relation to the feed screw.

The recorder head, MI-4887, is included as a part of the 73-A DeLuxe Recorder, and its installation is described below. When installed, the recorder head is rigidly attached to a small cradle, which, in turn is mounted on pivot screws in the carriage casting.

The 73-A DeLuxe Recorder employs a sealed inertia-type oil dash pot float stabilizer, the purpose of which is to supply adequate damping to the cutter head and cradle, and thereby eliminate any vertical oscillation (flutter) of the cutter head, which may be excited by the record while being cut.

The cutter engaging lever is used to raise or lower the cutter from the record. When the carriage is in the "standby" position, the feed lever is engaged, and the stylus is near the surface of the record so that it may be smoothly lowered to the record by operating the stylus engaging lever. A cutting stylus is not included with the 73-A DeLuxe Recorder so that for best results it is recommended that a sapphire stylus MI-4878-A be used in the MI-4887 Recorder Head.

Four Timing Scales are provided as follows, each calibrated for 96, 112, 120, 136, and 154 grooves per inch.

- One for Inside-out recording at 33 $\frac{1}{3}$  r.p.m.
- One for Inside-out recording at 78 r.p.m.
- One for Outside-in recording at 33 $\frac{1}{3}$  r.p.m.
- One for Outside-in recording at 78 r.p.m.

The scale marked "Minutes Inside-out" is graduated from the outside-in; and inasmuch as we cut from the inside-out, this permits the operator to set the indicator for the required length of recording. Likewise the scale marked "Minutes Outside-in" is graduated from the inside-out. For example, for a five minute recording, set the indicator at "5" and then cut to the zero mark. The best recordings are made at the greater diameter on the record. When an outside-in record-

(Continued on page 60)

# What's **NEW** in Radio

**New Kellogg Equipment.** One of the interesting American inventions which is being adapted to national defense is the latest kind of telephone transmitter and receiver combination which is devised for use of men in the artillery division. The receiver is strapped over the top of the head, and has a pair of large, soft rubber cups, completely enclosing the ear. This is to keep out the noise as well as to prevent concussion. The transmitter is unique in its design and construction in that the operating efficiency is maintained regardless of the position or angle in which it is held when in use. With this instrument the artillery can be directed in their maneuvers by telephone no matter how much noise and confusion surrounds them.

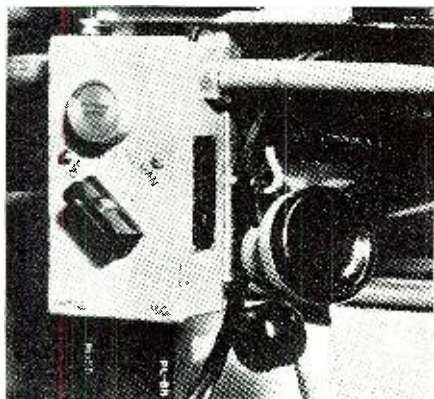

Another device is the head and chest set used by aviators. The microphone is held in position against the chest keeping the face of the aviator entirely free of any contrivance. The receiver units are extremely small and lightweight, and are sewed into the aviator's helmets.

Both this special transmitter and receiver set for artillery men and microphone set for aviators are manufactured by the Kellogg Switchboard & Supply Company, Chicago. They also make numerous other telephone and radio equipment such as switchboards, control boxes, filters, etc., that are being used by the army, navy and aviation divisions in the armament program. Many of these were shown at the National Telephone Convention recently held in Chicago. The large attendance at the Kellogg exhibit showed the keen interest of the trade and the general public as well in these improved instruments designed to increase the efficiency of Uncle Sam's fighting forces.

Microtube Laboratories announce a new line of ultra-miniature vacuum tubes designed especially for compact radio equipment such as hearing aids, balloon transmitters, receivers, and portable test equipment. At the time of this printing "Microtubes" are the smallest and most economical tubes available—says the manufacturer. Life expectation is in excess of 7,000 hours as indicated by accelerated laboratory life tests. These tubes feature Tetrode construction with beam tube performance.

An original and unique tube geometry eliminates secondary emission without the use of a suppressor grid. Accelerator grids are operated at potentials lower than plate voltage for highest "B" battery efficiency. In eliminating the suppressor grid a smaller overall diameter is likewise made possible. The plate current-grid voltage curve is exceptionally favorable to large grid excursions without distortion. "Microtubes" (external leads not considered) are no larger than the ordinary six volt pilot lamp in a broadcast receiver.

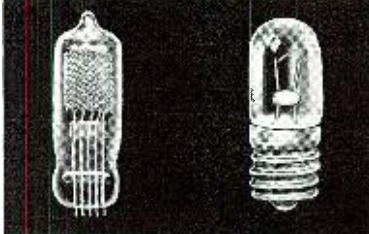

All filaments are of the 3/4 volt dull emitter type. The oxides are applied in such a manner that the coating is heaviest at the midpoint of the filament, tapering in thickness toward the ends. This means uniform temperature over the entire active length of filament. Maximum values of transconductance as well as emission life are thereby obtained.

Filaments are self-supporting, requiring no spring tension. Spring tension becomes increasingly hazardous to tube life when filaments of these ultra-small diameters are used. The "Microtube" filament is inherently free from microphonic vibration. A filament under tension is resonant to vibration the same as a violin string.

A high gain amplifier will readily demonstrate the superiority of "Microtubes" from a noise standpoint. Furthermore a spring hook which is not a filament lead, such as is used at the apex of an inverted "V" filament, conducts and radiates heat from the filament lowering the thermal efficiency of this type of filament. 1.4 volts accidentally applied to a single "Microtube" filament will not cause burnout. Specifications and other information are available from the Microtube Laboratories, 2414 Lawrence Ave., Chicago, Illinois.

According to an announcement just made by J. G. Mann, sales manager of Consolidated Wire & Associated Corporations, 526 South Peoria Street, Chicago, servicemen will now be able to secure Hi-Temp rubber covered hookup wire through regular jobber channels. Since its introduction early in 1939, this wire has been available only to manufacturers.

Hi-Temp, the first hookup wire of this kind to receive full Underwriters approval and label indicating it safe for operation in temperatures up to 75 centigrade, is now used in about one out of every three radio sets manufactured, according to Mr. Mann. He pointed out that this wire has been developed only after many years of research and that when finally released, it was seized upon wholeheartedly by leading radio set manufacturers. These set builders have found Hi-Temp exceptionally flexible and unusually easy to work with. It is offered in a wide variety of colors which makes possible color-coding according to exact R.M.A. standards of identification.

One of the latest products of Allied Radio Corporation, Chicago, is the new KNIGHT 30 Watt System with built-in phonograph motor and pickup. This unit is designed for universal and mobile use in sporting events, schools, road shows, army maneuvers, dance bands, skating rinks, airports, depots, carnivals, etc. Operation is from a 6-volt storage battery or from 110 volts AC. From either source full 30 watts output is guaranteed. Outstanding features include: inverse feedback; electronic mixing; two tone equalizers; speaker selector; "Safused" speakers; Beam Power tubes; Built-in phono top; standby switch; remote control; silencer jacks; illuminated panel; and many others.

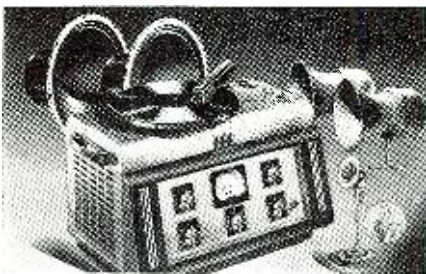

The entire 30 Watt Deluxe Mobile System is built around the compact single amplifier unit. Specifications are as follows: **Output:** Full 30 Watts usable power (37 watts peak); hum is inaudible (60 db. below rated output); **Output Impedance:** 2, 4, 6, 8, 250, and 500 ohms on speaker selector switch; **Input Channels:** Four, two for high-impedance mikes, each with individual volume controls, two for phono on fader control; **Tone Controls:** Two, attenuator type, one for treble, one for bass; **Gain:** On microphone, 135 db., on phono, 80 db.; **Frequency Response:** 40-10,000 C.P.S. (on amplifier); **Tubes:** 2—6SJ7, 1—6SA7, 1—6SC7, 2—6L6G, 2—6X3G. **Line Drain:** 140 watts AC, 24 Amps. DC; **Stand-by Switch:** To conserve battery drain; **Amplifier Size:** 19 1/2" x 14 1/4" x 13 1/2". E.R.P.I. Licensed.

A product of Allied Radio Corporation, 833 West Jackson Boulevard, Chicago, Illinois.

For fastening sheet-metal assemblies in which the parts must be readily removed and returned to position, a clinch type of self-locking nut with knurled shank is offered by Elastic Stop Nut Corporation, 2332 Vauxhall Road, Union

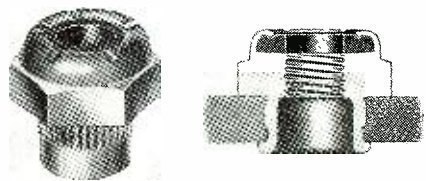

New Jersey.

To install the nut, a hole is drilled in the structure and the shank is pressed into the hole. The mouth of the shank is then spread against the back of the structure to effect a clinching hold. The knurling engages the drilled surface and thus assists in eliminating any turning of the nut.

The head of the nut is fitted with the vulcanized fiber collar which characterizes all types of Elastic Stop Nuts. This collar, being unthreaded, resists the entrance of the screw, thus automatically taking up all thread play and bringing the load-carrying thread faces of nut and screw into a tight pressure-contact. As the screw thread impresses its way through the collar, this pressure is maintained and increased to such a degree that the screw can not work loose, even under the most severe vibration. Because of the resilient character of the fiber collar, the screw may be removed and replaced repeatedly without loss of the locking action.

These nuts are available in a complete range of sizes, thread systems, shank lengths, and materials.

Universal Microphone Co., Inglewood, Cal., the first of the year started to distribute its latest catalog item to be known as the dynamic "Dispatcher" model, engineered especially for operators of wired music systems.

The breastplate type of microphone leaves the hands free to place the phonograph discs on the turntable in the control operating and control booth. The breastplate is finished in dialectic black finish and the adjustable neckband is of fabric material. The phone plugs to the tiny terminal box on the plate.

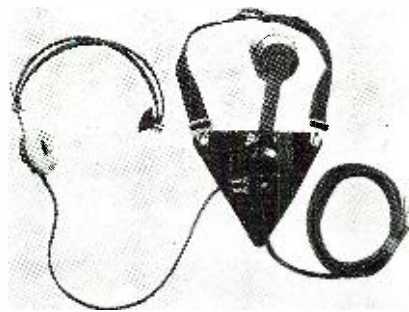

The new Universal product is available with the first of the year started to distribute its latest catalog item to be known as the dynamic "Dispatcher" model, engineered especially for operators of wired music systems.

Seven and a half feet of flexible cord is included in the assembly which weighs but a half pound. Lightweight, compact and rugged, it operates with remarkable efficiency and long life.

A "hybrid" of Universal's original airplane breastplate dispatcher mike, and its later chest model for amateurs and others, the new catalog item for wired music operators is expected by its manufacturers to be one of its fastest moving items in 1941.

Recognizing the inefficiency of ordinary plug-in filters, engineers of the Sprague Products Company, North Adams, Mass., have designed LF-2, a special multiple-section and inductance and capacity filter for use on very troublesome sources of radio interference. Designed for installation at the power outlet to which the interfering device is connected, the Sprague LF-2 takes much of the guesswork out of selecting the proper filter for any electrical device drawing up to 1/2 ampere. It has proved unequalled for troublesome electrical shavers, hair dryers, crasing machines and similar electrical equipment which so frequently causes the most troublesome kind of noise on nearby radio receivers.



Supplied in a good-looking, rounded corner rectangular case only 2 1/2" x 1 3/4" x 1 1/4", the filter is designed for use on 115 volt, AC or DC lines only. A ground connection is provided and should be used for maximum effectiveness. For convenience, this ground may be made to the chassis or frame of the offending device. List price of the LF-2 is \$3.50, net price, \$2.10 each.

The RCA 815 is a new push-pull beam power amplifier designed for radio amateur use at ultra-high frequencies. Its exceptional efficiency and high power sensitivity permit full power input with very low driving power. A single 815 operated in push-pull class C telegraph service is capable of handling a power input of 75 watts with less than 1/4 watt of driving power at frequencies as high as 150 megacycles. The total maximum plate dissipation of the 815 is 25 watts. The 815 is also useful as a modulator and as a multiplier. A single 815 can modulate another 815 as power amplifier. In multiplier service, the 815 can be used as a doubler or tripler and at the same time drive an 815 as power amplifier. Mechanical features of the

815 include its balanced and compact structure of beam units, close electrode spacing, short internal leads to minimize lead inductance and re-

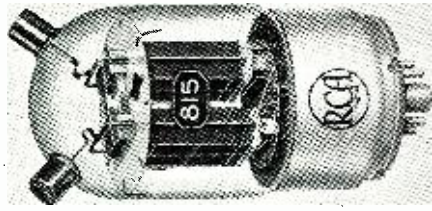

sistance, and a "MICANOL" wafer octal base. The heaters of the 815 are arranged for either 12.6- or 6.3-volt operation.

With the advent of 1941 automobiles, auto radio antenna installations have become a serious problem with the installer not familiar with the Ward Flex-Angle Antenna, Model E3-68.

The Ward Products Corporation of Cleveland, Ohio, will supply upon request an antenna guide (Form No. WA-107) of 1941 auto antenna installations and complete information on the only available antenna to fit all 1941, as well as previous model cars correctly.

A distinctly new type of receiver has been introduced by the Echophone Radio Corp., 201 East 26th Street, Chicago, in its Model EC-1 "Commercial." Its distinction lies in the fact that while in general it is of the AC-DC "compact" type, and serves all the purposes of this type, it also provides a number of features usually found only in receivers of the "communications" type.



Its tuning range, for instance, is continuous from 545 kc. to 30.5 megacycles and careful design results in real effectiveness throughout the shortwave portion of the range. Then, too, the illuminated dial is large in size, fully calibrated for all bands, and includes a separate band-spread scale and pointer, actuated by a separately controlled electric band-spread system. The four rotating knobs include those for main tuning, band-spread tuning, volume control and band-switch. In addition three toggle switches include a headphone-loudspeaker switch, a beat-frequency oscillator switch which automatically cuts out the a.v.c. system when the b.f.o. is switched on (to permit c.w. code reception), and a stand-by switch.

A 5-inch PM speaker is built into the cabinet top while headphone tip-jacks are located on the rear of the chassis. Antenna terminals provide for either doublet or single wire. Its six tubes include a 12K8, 12SK7, 12SQ7, 35L6GT, 12J5GT, and 35Z5GT.

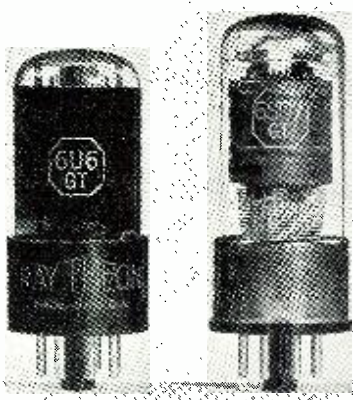

Raytheon announces several additions to the receiving tube line. These recently developed tubes are the types 6SD7GT, 6U6GT, 7L7 and 7N7. The 6SD7GT and 6U6GT fall into the beam category while the 7L7 and 7N7 are of the lock-in type.

These new types may be briefly described as

follows:

Type 6SD7GT is a semi-remote cutoff relatively high transconductance pentode for use as an R.F. and I.F. amplifier.

Type 6U6GT is a beam power amplifier designed for reasonably high output at lower supply voltage than normally required.

Type 7L7 is a lock-in base sharp cut-off relatively high transconductance pentode for use where the higher transconductance types are not required.

Type 7N7 is a lock-in base twin triode having separate cathode leads with consequently increased circuit versatility.

Technical characteristic data sheets describing the foregoing types are available from the Raytheon Production Corporation.

The famous Rider VoltOhmyst circuit, providing a convenient push-pull electronic DC Voltmeter-Ohmmeter with a resistance range ratio wide enough for engineering and servicing requirements for years to come, has been applied to a compact, low-cost instrument known as the RCA Junior VoltOhmyst. Its price, \$34.95, is expected to initiate a new era of high quality, low cost equipment for radio service and general electrical industries.



The RCA Junior VoltOhmyst incorporates every feature required for the ideal testing unit of its type. It is extremely useful for servicing radio and television receivers, transmitters, aircraft radio, sound amplification and reinforcement systems, facsimile and other types of equipment. Its features are similar to the laboratory type RCA 163 VoltOhmyst.

The new instrument offers servicemen many of the high quality features of the 163 VoltOhmyst, with the addition of an isolated AC voltmeter circuit. Its most appreciated feature is the complete meter overload protection on the DC voltage and Ohm scales. No damage can be done if the probe slips to a high voltage point when a low DC voltage is being measured.

The input resistance for measuring DC voltages is constant at 11,000,000 ohms allowing voltages to be read in high resistance circuits. On the 3 volt scale this gives a meter with a sensitivity of 3,666,666 ohms per volt! This feature permits the serviceman to read AVC, FM Discriminator, and many other voltages which are impossible with the ordinary meter. A Signal Tracing type probe lead is provided.

The DC voltmeter circuit has six ranges—0 to 3, 10, 30, 100, 300, and 1000 volts. It is not necessary to guess what scale is required before the leads are connected. The leads can be put in place, and then the range switch may be turned until the meter reads on scale. Considerable saving in time results.

This feature is also of value when resistance is being measured. In an effort to save time, resistances are often measured when the power is still applied to the receiver under test. Though this procedure is not recommended because of the false readings that might be obtained, there is no danger of meter damage even if the ohms measuring leads are applied to a "hot" plate resistor. The extended range of the ohm scales allow measurement of resistance values heretofore impossible except with costly equipment. Also there is no zero resetting or leads to short when changing ranges, resulting in faster measurements.

Aside from the electronic DC voltage and ohms measuring circuits, the Junior VoltOhmyst is equipped to make isolated AC voltage measurements as well. These are read on five scales: 0 to 10, 30, 100, 300 and 1000 with a sensitivity of 1000 ohms per volt.

The sensational RCA Junior VoltOhmyst and display may be seen at RCA Tube and Equipment Distributors.

Electro-Voice counter display. Dorothy Claire, beautiful vocalist with Bobby Byrne's Orchestra, is featured on the new counter display now available to Electro-Voice jobbers and dealers. It is an 11x14 inch, hand colored, original photograph, mounted and easled. Microphone used is the new CARDAK, a Poly-Directional Dynamic.

Write ELECTRO-VOICE MFG. CO., 1239 South Bend Avenue, South Bend, Indiana.

Bud Radio Inc. of Cleveland, Ohio, is now offering a complete new line of Code Practice Oscillators and accessories containing many new, convenient and desirable features. These new items are designed to facilitate both individual and class-room code practice, and are especially timely in view of the emphasis our National Defense Program is placing upon the necessity of having available a large number of trained radio operators.

CPO-122 is an Earphone Model Code Practice Oscillator capable of handling up to twenty pairs of earphones or up to five small magnetic speakers. It has a Variable Volume Control and a Variable Pitch Control so that both the volume and tone may be adjusted to suit individual needs. This oscillator is housed in a sturdy streamlined metal case finished in grey crackle enamel. A neat red nameplate is provided to identify the various controls.

CPO-124 is similar to CPO-122 except that it is provided with a built-in loud speaker. Provision is also made to operate up to twenty pairs of earphones or up to five small magnetic speakers. Both the tone and volume are variable.

CPS-123 is a three-inch magnetic speaker housed in a grey crackle enamel case. This speaker is intended for use with the CPO-122 and the CPO-124.

CPO-127 is a Key and Phones Outlet Box and is designed to provide a convenient means for terminating Key and Phones connections in class-room or group practice. Two appropriately marked jacks are housed in a bakelite box which can be fastened to the bench at each student's position. Each outlet box is then wired to the master oscillator.

Further information on these items may be had at your jobber's, or by writing direct to Bud Radio Inc., Cleveland, Ohio.

The sound expert who specializes in rentals finds definite advantages in modern 6/110-volt equipment in that a single unit of this type meets the demands for both mobile and indoor rentals. But because much such equipment has been mounted in carrying cases it has presented a rather makeshift appearance when used on indoor jobs.



In the new Lafayette Model 462-T the carrying case motif is eliminated in favor of a housing of beautiful design with portability provided by decorative handles. As a result the unit is entirely suited to all types of rentals, both in appearance and technical characteristics.

Technically, this Lafayette model provides identical performance or car-battery on a c. line supply and requires no switch operation for changing from one supply to another. Its output is 30 watts (40 watts on peaks) and is accomplished with two 6SC7's, two 6J7's, one 6E6, four 6Y7 G's and one 5Y4. Included are four input channels—2 mike and 2 phono—with simultaneous operation, mixing and fading of two microphones and one phono channel. Mike channels provide 130 db. gain and phono channels 90 db. Hum is 45 db. below 30 watts. Output impedances include 2, 4, 8, 16, 250 and 500 ohms. Provision is made for remote control, a stand-by switch is included on the panel, and low current drain is one of the outstanding features of the equipment. The phono equipment consists of a constant-speed motor, rim-driven turntable and Astatic tangent-arm crystal pick-up. Dimensions exclusive of turntable are 9 3/16" x 17 1/4" x 12 1/2".

A new line of AC Motor Starting Capacitors, of less weight, lower cost and smaller size than the cumbersome original product of several years ago, and a universal system for industrial capacitor replacement, have just been announced by P. R. Mallory & Co., Inc.

Costly small production runs have largely been eliminated because the new replacement units are identical to, and often a part of, large quantity production runs for current manufacturers' requirements. Semi-automatic equipment not available for production of old style units is now used.

Round types are housed in the smallest diameter and shortest height metal containers possible. Each unit is wrapped in a specially developed "size adjuster" for use when replacing original units of greater diameter and height. The corrugated adjuster is clearly calibrated for all popular sizes and may be readily cut with a knife or shears.

Rectangular types in three universal sizes are packed with complete hardware to replace orig-

inal capacitors of either lead, solder lug or stud types.

A new catalog with complete details and replacement recommendations may be had on request.

Clarion announces the release of a new portable automatic record changer-amplifier combination in the popular price field.

The Model C-182 combination is a wide-utility, completely self-contained record player with every modern convenience, including automatic record changer-mixer and built-in amplifier, loudspeaker, and phono oscillator. In an attractive portable case of airplane Pyro-tweed leatherette, this unit is ideal for an unlimited variety of applications. The automatic changer-



mixer plays twelve 10" or 12" records without attention, intermixing them in any desired order and with provision for rejecting any records not desired. Single records can be played manually when the automatic feature is not required. The pick-up is of light weight crystal type to insure long record life, and provides excellent quality of reproduction. Its leads are thoroughly shielded for completely stable operation and freedom from noise.

A 2-tube, high-gain amplifier and high-quality 6-inch PM speaker mounted in the front of the case make this a completely self-contained entertainment unit, and in addition a "Mystery" oscillator is built in to permit playing records through any nearby radio set, without interconnecting wires of any kind. A simple changeover switch provides instant choice of either of these two types of service.

Further information and catalog may be obtained by writing the Transformer Corporation of America, 69 Wooster Street, New York, N. Y.

**New Precision Tester.** The Series 954, combination dynamic mutual conductance type tube tester and 37 range super-sensitive AC-DC multi-



range set tester is a complete service laboratory in one compact unit. It provides every facility for accurate and reliable solutions of tube test and of measurement problems arising from modern radio (A.M. and P.M.), television, industrial and laboratory practice. 20,000 ohms per volt including ranges of 6,000 volts AC-DC; 60 microamperes; 12 amperes and 60 megohms.

Available in 4 models, complete with batteries and extra high voltage test leads (954MCP, an open type portable in metal case; 954C, counter type in metal cabinet; 954PM, in standard panel for rack mounting, and the 954P in walnut finish, hardwood, portable type carrying case with removable cover and tool compartment. Literature available from Precision Apparatus Co., 647 Kent Avenue, Brooklyn, New York.

Six new transmitter kits, engineered and designed in the Thordarson laboratories and characterized by their modern features, simplified construction, and efficient operation are now available through THORDARSON distributors. These new, smart appearing, streamlined transmitters may be built with a feeling of real satisfaction and with the assurance of having a high

(Continued on page 44)

## SERVICEMEN'S LEGAL ADVICE



**F**UNDAMENTALLY, the serviceman cannot at the same time be a lawyer,—that is, unless he is fortunate enough to have had legal training at some school. However, there is not any reason why the serviceman should not be acquainted with some of the simpler axioms and rules of law. He will need the knowledge of these in his everyday work and contacts.

Since nearly every service shop must operate from somewhere, and since most nearly that "place" is a store which has been rented, I have given the serviceman some very fundamental law on leases, this month. While it may be dry reading in parts, the information contained, if properly digested and understood, may act to save the serviceman many a headache and perhaps even a bit of money.

Do not be frightened by legal terms . . . they are meant to be merely English reduced to **exact** terminology, much the same as there is only **one** capacity of .002 microfarads. Legal language is as exact as radio language, and should be read with that thought in mind.—T. J. H.

### Leases

#### Creating the Relationship of Landlord and Tenant

**T**HE relation of landlord and tenant is always created by contract, express or implied, and will not be implied where the acts and conduct of the parties negative its existence. If the elements of offer and acceptance, express or implied, are absent, the relation of landlord and tenant does not exist.

In New York a suit<sup>1</sup> was brought by a landlord to recover possession of property occupied by a tenant. It appeared that the landlord had allowed the tenant to occupy a portion of his house after the tenant's house had burned. No agreement was made as to the length of the term or as to the payment of any rent. The Appellate Court held that the circumstances spelled out a tenancy at will. That is to say, that a "tenancy" had come into existence between the landlord and the tenant, and that the landlord had the right to recover possession even though no express agreement existed, but merely the permission to occupy the premises. The Court further held, that it was not necessary to show an agreement to pay rent to prove the conventional relationship of landlord and tenant.

#### Doctrine of Estoppel

A tenant is precluded from denying the "title" of his landlord. But loss of interest by the landlord may be availed of by the tenant. It has been said<sup>2</sup> that the loss of interest by the landlord may be used by the tenant, and the tenant may show that the interest of his landlord has expired since the making of the lease, or that he has sold and conveyed the land, or that he has been evicted by a greater title, or that the land has been taken from him by greater right.

It is elementary that the doctrine of "estoppel" extends equally to both landlord and tenant, so that while the tenant is "estopped" from denying the landlord's title, the landlord cannot allege that he had no title at the time of the demise. Nor can the tenant question the power of the lessor.

The Court has said:<sup>3</sup> "It is well settled that if a party enters as lessee of another, and the right of the lessor is in no way altered, the lessee is estopped from denying that relation. . . . The title he then acknowledges and accepts, he must abide by while the relation lasts. The result is the

same, although on the face of the lease it should appear that the landlord had no legal estate. If the parties agree that the relation of landlord and tenant shall be created, and this agreement is carried out by one being let into possession, then, as between them, the relation of landlord and tenant is created, and they are just as much estopped as if there had been no such statement. The foundation of the estoppel is the fact of the one obtaining possession and enjoying possession by the permission of the other. And so long as one has this enjoyment he is prevented by this rule of law from turning around and saying his landlord has no right or title to keep him in possession.

### Rent

Rent is said to be a sum of money or other consideration, issuing yearly out of lands or tenements. *Blackstone* defines rent as a compensation or return, it being in the nature of an acknowledgement given for the possession . . . such as a yearly profit, issuing out of lands. It must be a profit; but it is not necessary that it should be in money; for spurs, capons, horses, corn and other matters are frequently tendered and accepted as rent.

The rent of lands or buildings is such a sum as may be paid and realized from their occupation by tenants, and is fixed and certain, while "profits" are the result of trade, which is fluctuating and uncertain and dependent upon skill, care and the nature and amount of the business transacted.

### Privity of Estate

Cases abound in statements that no summary proceeding to dispossess a tenant and no action for rent may be brought by a landlord against a tenant unless it is made to appear that the conventional relationship of landlord and tenant exists.<sup>5</sup> The word "conventional" means an agreement of the parties and not a situation existing by operation of law. As before stated, an agreement showing the conventional relationship may be express or implied.

Where the ownership of premises has been conveyed, however, all privity of estate between the lessor and the lessee is ended. From that time on, there is no relationship of landlord and tenant and the new landlord, of course, is the grantee of the premises. Sometimes, the landlord may assign rents to a mortgagee, but this assignment does not destroy the relationship of landlord and tenant, even though the tenant might pay rent to the mortgagee under the assignment.

### Assignees

Where a tenant assigns his lease to another, the assignee is liable for the rent. The covenant to pay rent runs with the land, and binds the assignee, even though he is not named in it.<sup>6</sup>

### Nature of Lease

Technically and in its proper significance, the term, lease, refers to a deed of a less interest than the lessor has, for, as *Blackstone* says, if it is of the whole interest, it is more properly an assignment than a lease. Also, a lease is usually and properly in consideration of a yearly rent. An assignment, on the other hand, is properly the transfer of one's whole interest in any estate; but it is generally appropriate to the transfer of chattels either real or personal, or of equitable interests.<sup>7</sup>

While a lease is an interest in real property and is a chattel real, it is not real estate, but personal property. The term real estate has been defined in section 40 of the General Construction Law, which reads as follows: "The term real property includes real estate, lands, tenements and hereditaments, corporeal and incorporeal." These words do not include a chattel real. A lease is a "chattel

(Continued on page 62)

# Communication & Electronic MAINTENANCE

by W. H. BOHLKE

Director of Test Equipment Merchandising, R.C.A. Mfg. Co., Camden, N. J.

## Adding signal tracing equipment to the test bench.

### Part 4.

SO far in this series we have discussed a number of pertinent points, namely, the general requirements of the fields embraced by the terms "communication and electronic" servicing, the needs of a basic signal source for our shop which will meet all requirements and the nature of the operating and control voltages as well as resistance values which must be measured by our shop equipment during such work.

In this issue we shall expand the shop by means of two additional units and start the discussion of the actual servicing technique. What we have in mind is the means of localizing defects in these systems. The process we have in mind is signal tracing. And in order to present the subject in a logical manner, we deem it best to speak about receivers in a specific manner, namely to divide the receiver into two parts. One part is that portion of the receiver which is between the antenna and the demodulator or second detector, inclusive of the input system to that tube. The other part is the audio system between the demodulator and the speaker.

Up to the present time, servicemen have viewed this subject of signal tracing from the viewpoint of conventional broadcast receiver servicing—with one or more men, here and there, who may have had some explorer's blood flowing in their veins and applied the process of signal tracing, as best they could, to receivers outside of the conventional broadcast field. But today it is possible to speak about the application of the system to general communication and electronic servicing. It might sound strange, in the light of the three and a half years since John Rider first presented to the radio servicing industry the practical realization of an idea in his now famous *Chanalyst*, to say that most people do not wholly appreciate the significance of this process. This we have proved to many thousands of servicemen who have witnessed the signal tracing demonstrations using the RCA *Dynamic Demonstrator*, for after having read and re-read innumerable advertisements de-

scribing signal tracing apparatus, they still do not comprehend the tremendous scope of the subject.

Frankly it is not our intention to embark upon a tirade explaining the process of signal tracing or to establish that the system has proved itself. The very fact that thousands of such signal tracing units of varied character have been sold is in itself incontrovertible evidence of the fact that the basic idea was sound. The fact that those servicemen who have given the system a fair test, after having made an effort to really understand what it is, have become boosters, is all the evidence that the case requires. But what we really desire, is to bring to light the fact that signal tracing is not limited to conventional broadcast receivers only. We want to show that the process of signal tracing, inclusive of its recent developments, is the very basis of successful operation of our communication and electronic servicing organization.

Perhaps we are at somewhat of an advantage when we make this statement, for we are in possession of information which is not generally known. Not theoretical data, but actual facts—the results of actual tests made under the most adverse conditions and before the most critical of observers.

We showed in one of the early ar-

ticles of this series the wide range of frequencies which are to be encountered in communication equipment servicing. With some few exceptions, many of the frequencies listed also appear in multi-wave broadcast receivers. The fact that the ultra high frequency band found in aircraft equipment does not appear in general radio broadcasting does not by itself present such frequency problems as would draw a wide gulf between communication equipment servicing and home broadcast receiver servicing. In fact, we do not hesitate to say that, recognizing the peculiar needs of communication apparatus, the servicing problems are the same in both fields, for in both, the *signal is the common denominator*. The difference lies mainly in the nature of the servicing needed in one field as against what has proved satisfactory in the other.

In the communication field, the servicing procedure must be such as to produce the closest approach to perfect results. Not that perfection is undesired in the general broadcast receiver servicing operation, but as all of us know, much less than perfection has been acceptable—only because nothing vital depended upon the result and for the most part, good local reception was all that was required. . . . If, for the moment, we are permitted to forget the welfare of the institution performing the service operation.

High frequency operation upon the average home broadcast receiver has, in the main, been an uncertainty. True, sets were sold on the basis that foreign reception might always be had, but the public became accustomed to good reception one night and poor reception the next night. In fact, they became accustomed to the fact that during the daytime very little if anything could be expected. But in the communication field, a different situation prevails. Here the reliable reception which the average home set owner expects from his local station is very much needed under almost any condition and generally from distant stations. This means that the hit and

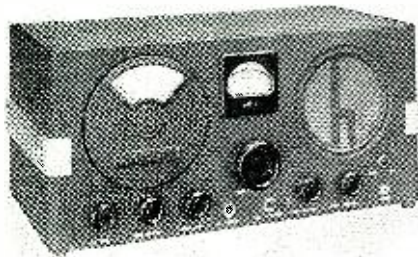

Hallicrafter's S-22R receiver.

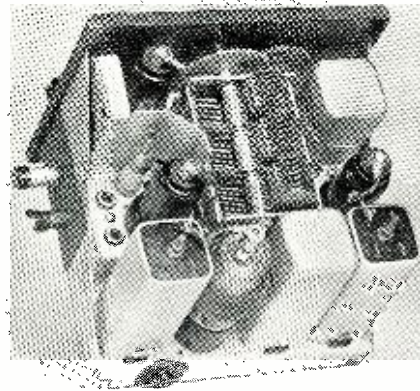

RCA AVR-20 aircraft receiver.

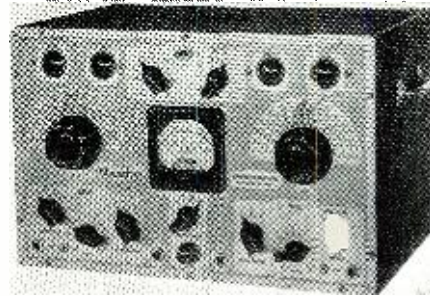

RCA (Rider) *Chanalyst*.

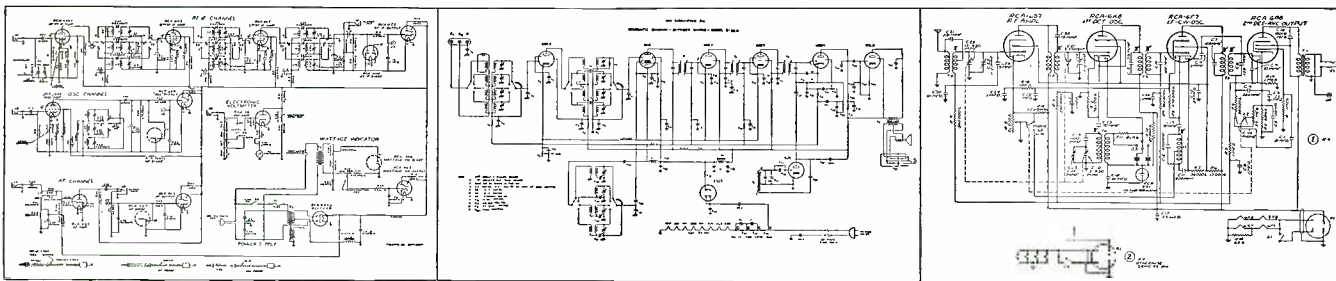

Circuit diagrams, left to right: The RCA *Chanalyst*, Hallcraft's S-22R and RCA AVR-20.

miss methods, productive of average results, cannot be tolerated.

It is in the broadcast receiver field that signal tracing has established itself over a certain frequency range during the past three years. Essentially this was over a range of from 100 kc. to 1700 kc. for the r.f. and i.f. systems and up to about 15 megacycles as far as the receiver oscillator was concerned. There have been shown in the past ways and means of extending the r.f. and i.f. frequency servicing range, but this involved a process of elimination which was totally satisfactory for home receiver servicing. But when we examine the communication field, we find that the process of elimination while workable, is not the best. Furthermore the requirements of the finished receiver being far more critical than that of the home receiver, require not necessarily more elaborate operations, but rather more deliberate and more accurate operations.

The man who has no intention of ever having a communication and electronic service shop need never, unless his vanity calls for it, extend his present day signal tracing facilities. Maybe the word, "never," is too definite, so we will modify it and say, for some time to come. But the man who is interested in establishing a communication service shop and looks to the future, cannot help but see that the effort made to create this service shop capable of servicing communication receivers as well as transmitters is *automatically improving the facilities* for maintaining the home broadcast receiver.

It is not strange to hear that ever since the development of the pioneer signal tracing piece of equipment, the *Chanalyst*, which was the forerunner of other equipment made by such manufacturers as Meissner, Jackson, Hickock, Supreme and others, that further development would go on so as to extend the operating frequency range in a manner compatible with the needs, as indicated by the design of the original unit. Such has been going on and along certain definite lines, in order to produce a piece of apparatus which would complement the original piece of equipment and extend its operating zone. It is only because of such development that it is possible to set up such a communication service shop, which it is felt will be in a position to render that mass service to the many in the future who will have occasion to demand it.

Up to the present time, the servicing of private aircraft and private marine and other similar specialized radio apparatus has been limited to a very select few. But with the trend becoming more and more evident each day, the need for extended servicing facilities over the high frequency band is growing rapidly. And this need must be

filled by means which are comparable to the demand—and by demand we mean not only the public in whatever guise he or she may appear, but the man who does the service work.

It is not within our province to criticize past servicing facilities of communication apparatus, but we can truthfully say that many critical men, very prone to say "No," have been shown that signal tracing is a more rapid means of servicing the most specialized of communication equipment, transmitters and receivers than any other method.

It is because of what we have seen that we speak. As many readers of this magazine know, we have demonstrated the application of signal tracing, but even our experience over the 100 to 1700 kc. band did not fully show what could be done at the high frequencies. We have seen engineers, who for years have worked with signal generators and conventional voltmeters upon the development of police equipment, struggle with service problems. Not because of lack of knowledge—of that there was plenty—but what was lacking was the means of localizing the defect *without taking the receiver apart*. Signal tracing did that at any frequency within any of the police bands up to and inclusive of 40 megacycles.

We have witnessed radio maintenance men, whose job it has been for years to repair some of the best communication receivers by means of point to point measurement of voltage and resistance, gasp in astonishment as the proper signal tracing apparatus located defects in a small fraction of the time at frequencies of even 60 megacycles. We have seen elaborate communication receivers of the aircraft variety which had been considered excellent in one location shown up to be faulty and then proved excellent in another location by means of signal tracing.

It is because of what we have seen, and because of the servicing requirements and the receiver requirements of the communication and electronic field, that we have assigned to our communication and electronic shop service bench the signal tracing apparatus. Two spaces have been assigned, one for the basic unit and the other for the complementary unit which will carry operation well into the ultra high frequency spectrum.

As you can readily understand, our test bench shows the *Chanalyst*, but the primary consideration is not so much the *brand* name as it is the fact that *such apparatus is needed* and is a "must" for the shop. Of course there are specific requirements for such equipment, as it must meet the requirements of the field. By this we do not mean that the communication receiver for aircraft, or police, or pri-

vate marine is so radically different from the home broadcast unit that there is no comparison. Such is not the case, even with the special circuits employed with the compass units in aircraft receivers. These receivers do not differ from each other in circuit structure. Such is not required—for after all, a signal is a signal. Where the difference comes in is in selectivity, image rejection, signal to noise ratio, stability, accuracy of calibration, high sensitivity, etc. And when these receivers are serviced, they must perform according to specification.

They differ in construction as compared with the home broadcast receiver. We understand, of course, that the so-called "midget" is pretty well crowded, but that is the midget. Communication receivers and transmitters are compact, yet stable. Therefore the means of testing must be such as to permit operation, compactness notwithstanding and at the same time not to interfere with the stability. Actually we are more concerned with the testing equipment the man selects for his shop than the problems presented by the receiver design.

Take for example the receiver circuits shown herein. Examine these circuits. You will not find radical departures from conventional home broadcast receiver circuit design. That which makes these receivers stand out is not visible in the schematic as a special circuit innovation. It is in the design of the transformers, the shielding, light weight—the use of components productive of minimum noise, the minimum interaction, the higher order of selectivity. . . . It is these problems that the test equipment must attack, that is, the rapid discovery of the location of the fault under such conditions—without tearing the receiver apart in order to make the tests. It was this accomplishment which made governmental agencies interested in signal tracing—commercial organizations who maintained worldwide radio networks. Those organizations who operated with high frequencies are now first becoming interested in signal tracing because of its ability to work at the high frequencies.

If we check through the various receivers made for different branches of communication irrespective of the nature of the service we find but few things which are different from all that has gone so far in the home broadcast field. This is not surprising, for, after all, the problems of the design engineer who is producing a multi-waveband home receiver to operate over a certain frequency range approach closely the problems of communication receiver design. Whether for a home broadcast receiver or for an aircraft receiver, the gain of a stage of r.f. amplification at some high frequency constitutes the same problem.

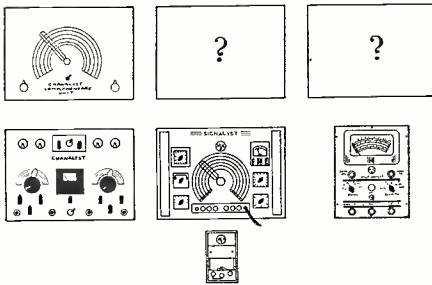

### Two additions to the service bench.

That is why we find that if a single r.f. stage is best for a home receiver it is pretty much the same for the communication receiver. So most of these receivers have a single r.f. stage. But—and this is an important “but”—the gain of the r.f. stage in the communication receiver is supposed to be a certain amount and the signal tracing unit should be capable of determining this gain *at the stage* and *at the frequency involved*, without disconnecting leads and parts—without disturbing the circuit.

Compass operation calls for a high order of selectivity in the receiver, the existence of conditions which are not found in home receivers. Granting the use of signal tracing equipment for service operations, this apparatus too has to meet certain requirements—selectivity requirements—sensitivity requirements—and still retain its stability and its property of application to a sensitive receiver without essentially interfering with the performance.

Communication receivers that operate at low signal levels, much lower than the average wide range of a.v.c. operation, over a signal voltage range as high as 200,000 to 1, consistent with high signal to noise ratio at the most sensitive conditions, call for test equipment capable of operation when the receiver under test is set for good sensitivity.

Selectivity is a factor in the receiver and it must be a factor in the test unit. Granted that there are several ways of checking selectivity, it makes most sense that the simplest be used, which can be equipment which is already connected to the receiver to make other tests. Such equipment is properly designed signal tracing apparatus, which in capable hands, can make myriad tests with ease. In this respect one receiver is like another, that is communication and home broadcast, but selectivity in the latter has been pretty much ignored, if only because the data required as reference is seldom available. But in communication equipment it is furnished with most every receiver.

Oscillator systems in communication receivers are not unlike those used in home receivers, except possibly for the use of crystals in the former, but these offer no more of a problem to proper signal tracing apparatus than conventional oscillators. To the service man, however, it is a variation from conventional procedure and means a subject for study, but this is anything but an insurmountable task. Frequency doubling takes place in some communication receivers, particularly of the ultra high frequency variety in the oscillator stage so as to produce a final heterodyning frequency of high stability. But the process of identifying the

manner of operation of these systems moves along prescribed paths like those laid out for the home receivers, more critical though it may be.

The i.f. systems employed in receivers outside of the home radio field are like those which the average service shop finds each day; that is, as far as the circuit is concerned. Even the fact that some special receivers employ three stages instead of the conventional two is not a radical departure, for we have seen three stage i.f. systems in home broadcast receivers. One difference is that the range of intermediate frequencies is broader, some receivers being as high as 4100 kc., but even this is not so strange in the light of the intermediate frequencies used in present day f-m home receivers. The use of magnetic core tuning, very common in these special service receivers, is like that used in some everyday receivers and a screw adjustment is only a screw adjustment even if one is more critical than the other.

Do not for one moment believe that these comments, concerning similarity and the ease of maintenance, are intended to convey the impression that there is nothing special about these receivers. There is, but usually not of such character as to be beyond the capabilities of the properly equipped service shop. We stress this point because so many men have felt that certain things were entirely beyond their remotest ideas of ability to serve, despite what claims were made to the contrary. If the regular service business had been built with receiver standards as precise as those which prevail in fields outside of general radio broadcasting, there would be no need for stressing these points. . . . The truth is the truth and it must prevail. Given proper equipment and in possession of all facts concerning a receiver, and the ability to interpret these facts, any serviceman will service any communication receiver. Television receivers are more complicated than these communication systems, yet servicemen, who have made it their business to find out what made a television receiver work, have proved that they are capable of maintaining proper service.

Concerning the physical design of these special service receivers, they are as a rule better constructed than home broadcast receivers. If ever you read the *Civil Aeronautics Authority* requirements before they license a radio unit for use on a plane, you would understand why. On the other hand, the construction is not of such character that it would bewilder the operator. The tubes are like those used in the everyday receivers—single ended and double ended. Maybe the sockets are better and the firmness of contact greater, but the parts are accessible from the top or the bottom as in any other receiver. Certainly there are times when some elements hide others, but these are encountered every day and it is here that signal tracing proves its time-saving advantages, for it makes possible total elimination of such resistance or voltage tests which would require the removal of some components in order to be able to get to the others.

Speaking about such voltage and resistance measurements we must cite one instance when such a routine of voltage and resistance measurement

(Continued on page 45)

## THE VIDEO REPORTER

by Samuel Kaufman

“AS these lines are being written—” It’s rather difficult these days to report on any video matters without the above preamble.

Reason: So many *sotto voce* activities are going on behind the television scenes and there is so much concern over the next anticipated video move of the FCC that virtually every firm concerned with the art of sending or receiving moving images through the air is in a state of bewilderment.

So we will employ that phrase once again in reporting our impression of the current video scene. Here goes:

As these lines are being written, there is a sudden stir of activity in New York television circles. The *NBC-RCA* station has emerged from its autumnal hibernation to resume a skeleton service that is a mere shadow of the thriving schedule maintained just a few months ago. But, at that, a few hours of video programs are better than none at all. Or, are they? Any doubts are prompted by the apparent shearing of production expenses.

Yet, it is difficult to blame the officials of video station W2XBS for their economy in the face of the uncertainty of the next FCC move. As a matter of fact, many persons in the industry—in and out of the *RCA* family—were mildly surprised at the resumption of service.

And it is quite likely that the *RCA-NBC* unit would not have resumed service as yet, were it not for the sudden television publicity accorded other companies.

Although there was a general belittling attitude at *NBC* regarding the sudden attention given to the *CBS* color television method, the *Radio City* lads had to recognize the fact that the *Madison Avenue* opposition was getting such widespread attention that the public was marvelling at the *CBS*



Television is again active in N. Y.

achievement while forgetting about all the constructive things done by *RCA* and *NBC* in the past.

The first rule of success in the show business is to keep yourself before the public eye. And *CBS* pulled a trump card in staging its color television demonstrations while W2XBS was in hibernation. Regardless of its merits or shortcomings, the *CBS* color television plan was the fascinating thing that captured the fancy of radio listeners hearing about it. And those very same listeners are the look-and-listeners of tomorrow, and getting anything across promotionally at this time is an invaluable merchandising achievement and asset.

Another thing apparently came to the attention of the *Radio City* lads. From their very own location they saw a television antenna go up atop a skyscraper just three blocks away. It meant that programs would soon be emanating from it to the New York

(Continued on page 63)



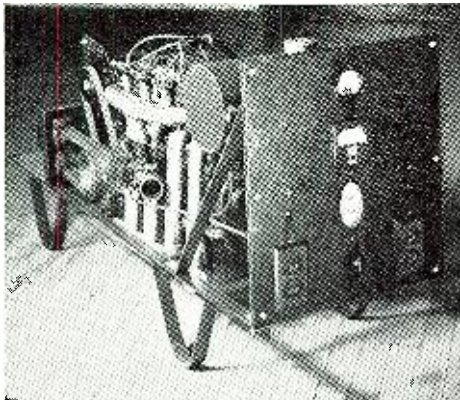

A unique QRR power supply "sled" owned by w1bkg.

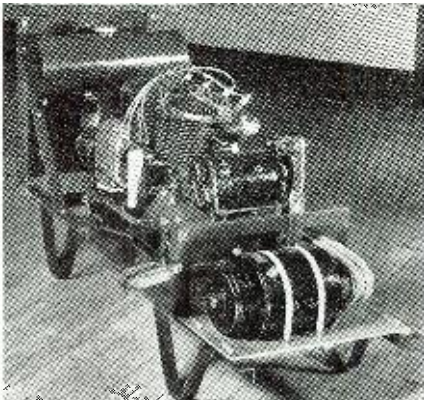

Back row: w5: ege, ewd, hmv, & fch.  
Front row: w5dan, w5igw, and w5gx0.

# HAM CHATTER



Apt. house hamstation w2hnj.

**P**RIZE offer: YE OLDE HAMCHATTER EDITOR offers a prize—no, by golly—two prizes of \$5 each for two best letters. The first fin will go to the best letter from some OM ham as to why we SHOULD'N'T run the YLRL news; and the other five simoleons will go to the OM ham writing the best letter as to why we SHOULD run YLRL news. The HC Editor is sole judge, and his decision is final. Everyone except employees (and their families) of the publishers may compete. Duplicate prizes to duplicate winners. Come on, you hams, here's yer chance! Don't pull your punches . . . don't be afraid, we'll withhold names if requested. . . . But, try and be gentlemanly, if possible! Next month, or after the prize contest is decided, we'll give the gals a chance to answer, for the same prize money!

**N**OTICE TO ALL HC READERS: Don't fail to read the Washington Communication this month. It contains valuable info on what is being attempted in your ham bands and in the matter of new ham licenses. We will appreciate your letters on this point.

**T**HE RADIO MINUTEMEN OF AMERICA are going over fb. To date their number is over 1000 and more come in with every mail. While we here at the temporary headquarters are prohibited from telling how much good the RMMA have been doing, we can say that they have been instrumental in uprooting some 5th Column activity in some very little-known places. In addition to this we have letters of commendation from the FBI, the G2 of the Army, and other Government arms interested in combating the 5th Column in our country. It was, indeed, surprising to see how many reports we have been forwarding, and more surprising that there were so very few "crack-pot" reports. When the story will be able to be told, the RMMA will be able to say that it has done the country a real and efficient service. More power to them.

Incidentally, the rolls are still open for new members. There are no dues, nor need you buy any book or magazine to be a member. Drop us a postcard asking for info, and the return mail will bring you the dope.

**H**AMNOTE: The BLACKHAWK RESTAURANT of Chicago, Illinois, may become the meeting place for all hams on every Tuesday nite. Watch for important details here next month. There will be a floor show same as always and hams displaying their tickets will get their parties in for 2/3rds of the regular minimum. Cy WJAA Reed and his Ork are being talked into going in for that evening, and a wire on WGN is being dickered for. Will

be a nice place fer youse guys and gals to meet your brer hams and their yls and xyls every Tuesday nite, and trip the light fantastic 'n stuff. They have TWO bars there, by the bye! Sponsorship of the CHICAGO AREA RADIO CLUB COUNCIL plus RN to guarantee no loss to the owner. A five dollar prize is being offered by HAMGAB, publication of the Hamfosters Radio Club, Inc., of Chicago, for the best letter suggesting what type of ham entertainment should be furnished and what should be done on the 15 minute B.C. period. Get in on it. Write your entry to HAMGAB, c/o Leslie Morey, Editor, 118 East 26th Street, Chicago, Illinois. Gosh, more prizes than anything!

**H**AMGAG: Then there's the one about the ham who, seeing that the new rags prohibited wrkg any portable from anything but batteries, got hisself a mess of storage bats totaling 115 jolts of DC. Dragged out his whole shaek in a trailer, and set up fer some real nice dx, turned on the juice and got hisself such a shock from the bats, that he spent the week-end in a bonejernt (hospital, to youse guys) and never did get on the air at all. Next week the payment house foreclosed on the trailer fer failure to pay the installment, and since he now has no trailer, he's looking fer some ham to buy his bats. Bats . . . we'll say he bats!

**T**HIS morning's mail brought the following from the Federal Communications Commission. Since it seemed just as if "Philo Vance" had come to life, and since it shows how remarkably well our FCC is "on the job," we herewith reproduce it in full.

**A** MONTH'S search by the Federal Communications Commission for unlicensed radio equipment which broadcast "sure tips" to favored bettors, while horse races were still being run was climaxed last night by the arrest of two men and the seizure of illegal apparatus at the Charles Town, W. Va., racetrack.

In early December Commission field men discovered that two portable transmitters were surreptitiously being put to such use. One transmitter concealed under the coat was employed by one of the men in the grandstand to communicate progress of the race to an accomplice in a rented tourist cabin near the track. The latter utilized the second set to flash the expected result to conspirators listening in at outside receiving stations. Under this system, some persons were able to make advantageous bets before the results of the race were generally known.

The method of operation, as determined by Commission inspectors listening in, was this:

At the start of the race a person could be heard whistling on a certain radio frequency, followed by the words "Oh Johnny" repeated



The ever popular w5dan.



QSL card of xyl w9dbd.

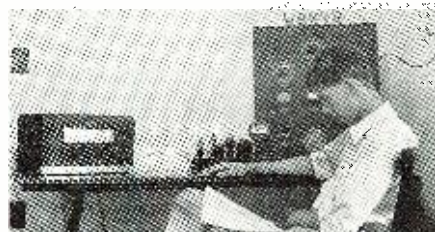

Hamop w9kyr es his hamstation.



"Doesn't my vine grow nicely on the wires you strung for me, you darling!"



Platteville's (Wisc.) w9qfo.



A Canadian gov't 5-watter, cz2z.



w3cft.



w9seg.



Hamstation of w5hrc.

several times, and then a few bars from such songs as "Beer Barrel Polka" or "Maryland, My Maryland" would be sung. As the race neared the finish the voice would suddenly cut in with a number, repeated until the race was completed. Immediately after this number was spoken, a stronger signal on another frequency was observed to repeat the same number perhaps 10 or 15 times, followed by such commonplace expressions as "testing" or "testing for modulation," and finally the words, "that is all." On checking the race results it was obvious that the number in question referred to the number of the winning horse.

By the use of highly specialized equipment and technique, the party in the grandstand operating the transmitter concealed on his person was finally located. This transmitter was adjusted to an ultra-high frequency and the microphone extended down into the sleeve of the overcoat worn by the operator. To speak into the microphone, he merely raised his hand to the back of his neck and appeared to be conversing with his look-out companion, or shouting for his favorite horse to win. To allay suspicion, he carried a program and consulted it between races.

The grandstand tip-off man had a clear view of the tourist camp in which the high-powered transmitter was located, and received acknowledgments of the reception of his transmission by light signals flashed by the operator at the tourist cabin. On one occasion, the operator in the grandstand remarked on the air that a clothesline obstructed his view of the light. This announcement enabled the inspectors to verify the exact cabin in the group where the presence of the high-powered radio transmitter had been previously located by a radio direction finder, even though the antenna was concealed. This transmitter was built into a trunk and when the lid was closed gave no semblance of a radio apparatus.

Arrests were made in cooperation with the West Virginia State Police and United States District Commissioner at Martinsburg, after evidence had been presented by members of the Commission's field operations section personnel—Charles Ellert, Supervisor of the Central Atlantic Monitoring Area; Assistant Monitoring Officer Earl M. Johnson, and Radio Operator Kenneth B. Menear.

*Guess I'll turn on the rig.  
Gee! those filaments are bright.  
Hope I can work a lot of DX  
Without QRM and QRN tonight.*

*Here goes the power to the final,  
Gosh! that tube looks kinder blue.  
Seems the aerial don't like to take it.  
Well, anyway, here goes a CQ.*

*Nobody answers my calling,  
Am I way down in the mire?  
Don-gone-it carn-urn plug-take-it.  
Ha! Ha! Forgot the aerial wire.  
By J. Lee Yates  
(W7FHC)*

**66 LE' DON B. (W9KOH) SUMMERS** hits us wid:  
The Sweepstakes was a big thing this year, I believe more fellows took part because, of course, there will be no DX contest. My score was 240 contacts this year to 160 last year, and I put in less time this year.  
160 meters has been doing things lately, in the daytime it sounds like 75 meters and the DX comes through much earlier in the evenings. A bunch of us 9's worked W6TAV in Calif. recently at 9:30 P.M. which is very unusual. The new portion of the band has better DX on

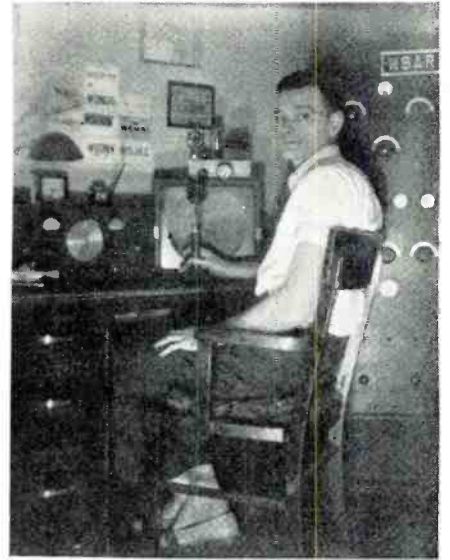

World's tallest ham, w9ari.

it, too. I think, because it is so much closer to the 75 meter band.

W9ROQ is now slipping around the bands with a new ECO. Brownie always has a swell sig. over this way.

W9YFB finally got down on 10 meters, is putting in some new towers on 160 meters, too.

W9ZLV has increased power with results of a fb sounding rig.

Flash—By this time W9WSH should have a new Op. over at his place. Was it a boy, Herst?

W9MAE is a new ham on at Kansas City, fine sig there Dour.

W9ECZ and XYL W9MRO have new fb antenna's up now and are both doing a swell job on 160 meters. Glad to hear you both back with us.

W8OZP recently lost most of his QSL cards in a fire; most of his equipment was saved, but Auburn would appreciate cards from any of the boys he has worked in the past.

W9IVJ is doing a fine job with 140 watts from over in Oswego, Kans. Call us again, Bill.

W9UWL is sure doing something with that KW he has on 160 meters now. If he just had a good receiver Pete would be on top of the world. Hi Pete.

W9OSP sure lays down a real sig. with that 40 watts.

W8PDP, W8QXF and W8SEW way out in Pa. were sure putting fine sigs in here on 160 meters last week. Nice going boys, cu again soon I hope.

W2MPR from N. Y. lays a wicked sig out this way too, some roundtable, eh Homer?

W9NWB is a new ham in Columbia, Mo. Only 25 watts, but Bud does O.K. up this way.

W9AIF is putting up two 75 ft. towers, and Oh Johnny I bet you get out in a big way. Here's hoping, anyhow, pal.

W9RWC was fooling around with only 3 watts the other night, and got some very fb reports. Bob really does fine with a 100 watts, too.

W9GWV is doing fine up at Clinton, Ia., now, too. Ben is always a fb contact for a rag chew.

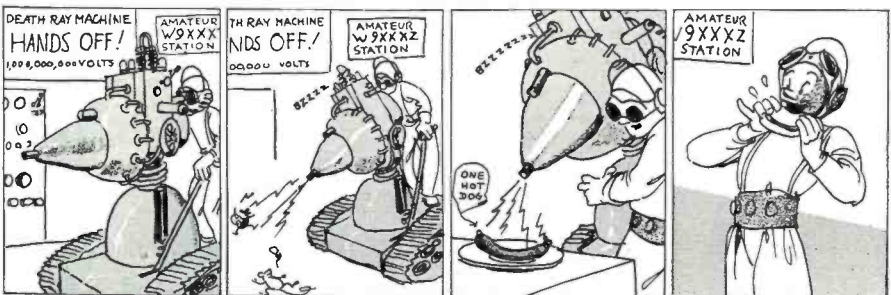

"Nothin' like building something practical, now, is there?"



"Come on down, it's bucklin'!"

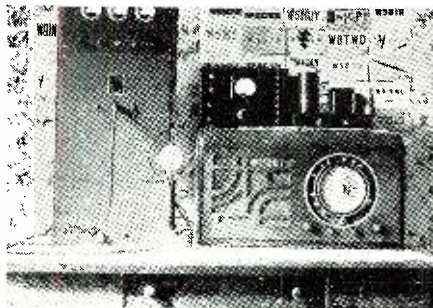

Hamstation of w9drt.

W9HS, what's the matter Scotty, are those blondes taking up all your time now? Long time no hear.

**R**AY SPEJNA, of River Rouge (why, oh why is it river ROUGE, and not RED river?) says:

One Sunday, W8OWY, W8PEC, W8PVN, W8SLS, W8TUX, a few owls, es a few lads who hv taken the exams but did not rev their tickets, had a ham gathering at W8PVL's shack. Half the gang couldn't fit in the shack. But boy, did they have a rollicking time! Joe still invites all owl es hams who care to come. Think twice, Joe.

W8LMV, Ray, es W8LTH, Emil, sure hv W8HRI hemmed in, for Al moved into River Rouge between Ray es Emil.

W8UHQ was seen painting his QTH this summer. Bill is in no hurry to finish.

With all the other side lines, Joe, W8PVL has taken up flying with Q8LT, W8PWN, Frank, alias Mac, W8OTE is fed up with ham radio es is quitting the game (this is the 2nd time, eh, Mac?) It's okay for the summer months, but watcha going to do on these long winter nights?

W8KZR, Charley with W8RWE, Guss started to clean up the 160 meter band for the sake of Amateur Radio. But when a meeting was pulled off—no Charley—Focoy.

W8KXK, Nelson, was in a 27 station round table A.M., included were 4 Californians es nearly K4, Rudy, es up when it's my turn.

W8SEC, Rudy, of Lincoln Park, is wondering if some of the boys are just holding him on the low power they run, because he can hardly hv the higher powered Ohio stations, but one day he contacted a few of the Ohio lads who were coming in a QSA5R8 with only 7-8 watt input with a 6L6 in the final. What about your low power, Rudy, you certainly get out.

Once Mac, W8OTE was figuring on going into business by selling canaries that were large as eagles. Mac said that by putting one of his canaries into the final tank of a 2 1/2 meter rig will enlarge the canaries as large as eagles.

Coe W8NBM, of Ecorse, who was running 30 watts boosted his power to 60 watts. All Coe did was re-check his power with reliable meters.

W8TUX went north to the upper peninsula last summer, es did not take a portable rig as planned. But kept a schedule with Joe W8UAS through another ham from up north. How you feelin, Al?

During the winter months, W8PHL's cat sleeps in his rig. Cal used to wonder where all the hum was coming from.

Ed, W8QUU, of Wyandotte, who was on 160P called a short CQ, 40 meters 3 different times es got 3 different answers from 40. Hi.

W8SEC, who sez he is only running 20 watts input, sez out much better than he ever did with the old rig. Sounds like 200 watts in the down-river district. Better check your power more carefully, Rudy, and I'm not kidding.

W8PHE, Vernon, recently put a transmitter in a boat. He also spends many hours in the garden, es he's a fair golfer.

W8UKV, Dale, es hrd on 160 P with 25 watts. Better late than never but congrats are in store for Guss, W8RWE of Wyandotte es Coe, W8NBM of Ecorse who are the proud papas of jr. oprs. The stork arrived with the joyful bundles way back in April. Hv a cigar!

W8HIA of Dearborn who is hrd on 75, also is a proud papa of a fb yl. The pr opr will keep Red off the airways, for awhile at least.

W8LTH worked all month re-building his amplifiers to get rid of hum. It's not objectionable now, Emil. The crystal mike sounds better, no carbon roar.

After getting tired of the higher freq, the great cw man W8MXU, Jule of Lincoln Park, come down to 160 to hook some real dx.

Jerry, W8IVA of Ecorse, running low power was heard 60 miles away a QSA5R9 on his 2nd harmonic es only a R7 on his fundamental. Hi.

Dave, W8KFC, runs his rig remote control from the front porch. What about 2 1/2, Dave?

W8UWI has a ry fb sig, 42 use es 802 final wid 25 watts input. Chet is contemplating on getting a commercial revr.

W8UQL was heard on 160 CW, Jerry, W8OWY of W. Detroit, is back on air after a long lay-off, on acct. of plenty of school work.

Old timer, W8FPR, who has an ECO does a lot of freq. shifting.

W8URO is trying to get his rig on 10, but no go.

W8LSR of Wyandotte, sure pounds thru wid 5 watts on 160 P. The peanut whistle was Joe's 10 meter portable mobile outfit.

(Pse QSY to page 64)



**F**ROM just around the corner, a hoot and a holler down the road, (roughly 20 miles away from the ranch of ye ed) comes the clarion call of sleuthhound Charlie Duvall, who unearthed the whereabouts of Brother Alvin Rainsey's buddy, "Doc" Amos. He sez for Ramsey to shoot a msg to the Postmaster at San Diego, Calif., where "Doc" is doing time as a postal clerk. And if this doesn't get our man, Duvall remarks as how the Sheriff of San Diego county would surely know where Amos is hanging his hat nowadays. So another shipmate is found and the old colyum feels justly proud of its record. Incidentally, Brother Duvall has a radio shoppe in Santa Monica, Calif., and issues a blanket invite to all ye brethren who may be troddin' the soil around that seaport to partake of a pot of java with him.

**B**ROTHER (CJ) BOLVIN sends in a map of his airline's new routes which he sez, "as you can see this made quite a number of new jobs available. The company has hired about twenty new radiops in the past couple of months. Some are OK and some are lo. . . . But the punks will get slowly weeded out. They are allowed plenty of time to show if they will improve enough to hold down the job, but if no sign of improvement . . . well . . . One thing that has been quite obvious though is that there are very, very, very few good ops around loose."

**C**J sez that "Braniff has a new route into Amarillo and Penn-Central has a nice long one with about five new stations. This outfit just created a new job . . . radio supervisor. Johnny Crisford, formerly op at this station, got the job. This outfit will in all probability be signed up with the ALCEA (Air Line Communications Employees of America) within the next month as most of the major stations are already signed up 100%. ALCEA is favored by the "Airline Pilots Assn." so there is a good chance of its going places. American, Northwest, Chicago & Southern and Braniff already are in and I believe that Continental will be taken into the fold shortly. ALCEA is going after the teletype ops. So if we get chased by the old Debbil Teletype, we'll still be protected, hi." Incidentally, Brother Bolvin pulled a fast one on Winchell. His wife presented him with a baby girl, Patricia Lynn, without Walter's knowledge. Congrats, OM, and may the YL bring you and the ex-yl lotts a luck.

**T**HE ALCEA organization is the answer with which airways ops have long tried to interest the two marine organizations, ACA and CTU-Mardiv. This column endeavored to show the unions that airways radiomen were part and parcel of the radio field and should be organized for the benefit of all concerned. But for some reason the airways ops were lone sheep, helpless to the attacks of teletypes and glamour. Finally, ALCEA comes along and from all reports seems to be doing a swell job.

**B**ROTHER Frank Howe of the CTU-Mardiv wants the world to know that they've just obtained a ten dollar per month increase for the radiops of the Eastern SS Lines, the Ocean SS Co. of Savannah, the Carter Coal Transportation Co., and the Atwacoal Transportation Co. The total number of ops employed by these coastwise boats totalled forty men. Which is known as "wholesale" work and darn good work, too. Ask the ops affected. Also, CTU-Radiops on vessels of the Waterman Line, coastwise and intercoastal, are receiving \$145 per month for straight radio duties. Who sez that results don't flow from united appeal?

**F**ROM all we've read in the papers, it seems that ACA-Mardiv took an awful shellacking when the Neutrality Law went into effect and American owned vessels were sold to foreign flags. Ninety ACA radiop-manned boats were thus taken from under these ops who are either beached or assigned to other ACA-contract vessels. With the FCC and Air Lines opening up their arms for good radiops these men should not find it difficult to get placed, that is, if they can qualify. A radiop is a radiop no matter where you put him and if you need any proof of that a visit to any VWOA smoker will convince the skeptics.

**D**URING the recent argument between the ACA and CTU-Mardiv over the radiop billet on the SS President Van Buren, Brother Vernal C. Dean, radiop on the ship, was advised by his organization (CTU-Mardiv) not to leave the boat unless he was properly compensated for the indignities suffered by him. So the company paid Dean \$444.99 over and above the wages due him, plus transportation back to New York. And it wasn't long ago when a man was told to "scram" off a boat and whistle for his dough even though he was far from his home port. How times do change.

**B**ROTHER Karl Baarslag, author of four well-known books, the last being "Islands of Adventure" which is a killer-diller, took the Yacht Rene, owned by General Motors' Alfred Sloane, from New London to Miami recently. Karl certainly should be able to tell us guys how the other half of the world lives, inasmuch as his last few years were spent on the Yacht Vagabondia, Andy Mellon's uncle's ferry boat.

**F**INAL—50— Brother John Harton, CTU-Mardivop, met death by drowning while employed on the Tug Peacock in the harbor of Cartagena, Columbia. The Peacock sank as a result of a collision. His many friends mourn his loss.

**B**ROTHER Norm Underwood of Marine Communications WLO at Mobile, Alabama, has been duly certified and unanimously elected "Gulf Sleuth." He sez a most hearty welcome is extended to shipops who care to drop by WLO. The station is located at Pier A, South, Alabama State Docks, and is on the way to town. Drinks (soft) will be kept on hand so that stopping by won't be a complete loss of time. Any ops who show me how to exterminate the "bugs" that are so prolific in the xmtr will get two drinks," sez Norm.

**B**ROTHER Charlie Hahn whose boat, the Tanker Thermo, stopped off at Mobile, was struck down by an automobile whilst tripping across an intersection. He suffered a compound fracture of the right leg and other injuries. He's laying up at the City Hospital and would like to hear from the gang. Editor's note: a letter now would be worth sixteen later.[

**B**ROTHER Kenneth Wasserzieher, who spent several months on a Norwegian vessel, quit the ship when she reached Mobile and got a job at the Alabama Drydock. They put him to work on the same boat. He sez they are putting a deGaussing (anti-mine belt) around the vessel and are encasing the radio shack in concrete. Guess he got off just in time. . . . Brother Arsenio Perez brought the new M/S Shooting Star from the builders' yards in Tampa to town, (Continued on page 59)

# Ring the Bell

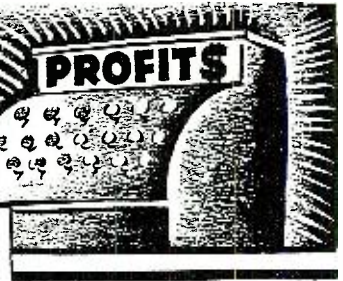

It can happen here! The chain-store radio service idea could be operated.

by SAMUEL C. MILBOURNE

Expert Serviceman, Greenwood, Miss.

THIRTY-EIGHT MILLION home sets and 6,700,000 car radios are in use today. An average increase of three to four million sets per year has been shown for the last five years. An estimated increase of four and one half million sets per year is predicted for the next five years. The war in Europe has resulted in people using their radios more than ever before.

This is the picture presented to the service branch of the radio industry by the set manufacturers. A rosy picture indeed, but to what extent is it being grasped and developed by the average serviceman?

Some \$30,000,000 was spent for parts (including tubes) and about an equal amount for labor during the last twelve months. This amount was paid into the pockets of the radio service industry by those who want to "sit in" on the greatest show in history. Sixty-million odd dollars is a tidy sum and not to be brushed aside idly when reckoning the financial success of an industry born of a vacuum!

However, this averages about \$5.00 per set serviced (based on an average assumed serviceman's yearly sales of \$2,500 for 500 service calls).

"Pretty good," you say. But—is it? There are some 45,000,000 sets. Subtract 7,000,000 sets purchased within the last year and one-half on which no service is required and you have left 38,000,000 potential repair jobs! Now divide 38 million sets into the \$60,000,000 received and you find that but \$1.66 average was spent per set to keep them in operating condition. I make the statement that over half of these sets are badly in need of repair, nine-tenths of them will stand a re-alignment and twenty percent of them aren't even in playing condition!

How come? What's the trouble? Why aren't servicemen out after these

sets? Why are not servicemen among our best paid merchandisers of service?

The answer thunders back—because they aren't merchandisers of service—they haven't been taught to sell themselves! They are technical men—not salesmen. They are masters of the radio body, and, for the most part, novices of the human soul. Servicemen admit it. They say that there is no time for studying how to sell a

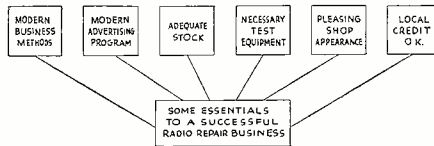

How the chain-store would function.

customer service, it takes all their time to study how to render, partially, what repair work they do get.

An unhealthy condition, my friends, and one which must be speedily remedied or one of these days the serviceman, the jobber and the whole group of men who depend for the most part upon individually rendered service work, will awaken to a new factor—the chain radio service shop.

Think it can't happen? Is it really that funny?

Strike the scales from your eyes and see what has happened in the food industry, the clothing industry, the automotive parts distribution system.

Look what has happened in the radio parts distributing system where chain jobbing has become a major factor. Look to the radio manufacturers who set up their own parts catalog with which to woo the serviceman.

Then, ponder the fate of the individual serviceman.

Chain radio service is not a new idea. It was tried years ago. In some sections it is now in use.

However, the chain radio shop of yesterday and the chain radio shop of tomorrow are two entirely different pictures.

What are the factors necessary to the success of any business?

First, a need for the product or service is required. Certainly, the need in this case is apparent. Every set should have a periodic inspection—preferably once a year. This means that there should be at least 36,000,000 radios inspected and either repaired or at least adjusted every year. Last year, a maximum of 12,000,000 were repaired. A batting average of 0.333. Yes, the market is there!

Second, there must be a product to sell—developed by the producer. The original producers in this case are the radio manufacturers. Together with the broadcasting interests, they are responsible for the program reaching the home. Yet, what have they done to assure the radio owners of a satisfactory continuation of this reception?

The program is the product to sell. Adequate servicing facilities must be available for the success of the product. Thus, service must be sold and the public educated to a proper appreciation of what a good service job really means.

Before continuing, let us first acknowledge all the efforts that have been made in this direction by manufacturers, jobbers, broadcasting systems, service organizations and individual servicemen, themselves. This is not a black and white proposition—it is not an open and shut case against the industry. But time flies and the public as a whole still awaits a real educational job.

This brings up the third factor of any larger businesses' success—distribution. As the situation now stands, the parts manufacturer sells his parts to the set manufacturer who assembles and sells the set. He also stocks replacement parts which in turn may pass through a wholesaler or, at least, a branch warehouse before being received by the radio jobber. He, in turn, sells to the serviceman who makes the actual replacement in the customer's radio. Not all parts follow this procedure, but it is typical of a portion of the distribution system. What would be more logical for the same large organization to which we previously referred, than to make arrangements with the set manufacturer for delivery of such parts direct

## WOULDN'T THAT FLOOR YOU?

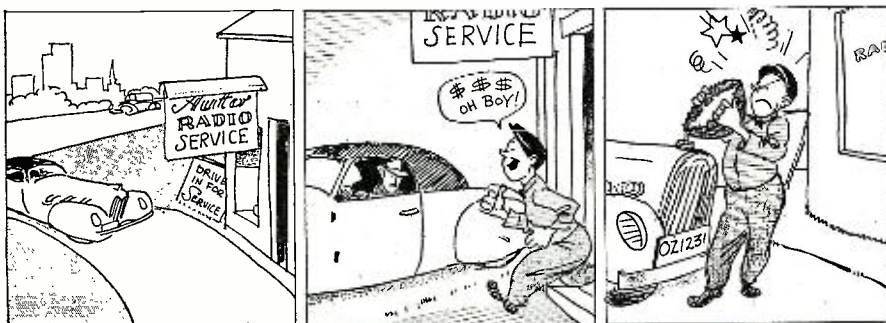

from the parts manufacturer to sectional warehouses from which they would be drawn by branch managers. Probably 80% of the original replacement parts could be purchased directly from the parts manufacturers without the set manufacturers even being consulted on the matter.

The fourth factor, and one which the writer feels is lacking most in the present set-up, is adequate and cohesive modern business and advertising methods. Servicemen will not advertise. They will not contact their old customers for repeat business, nor will they make any consistent effort to add new customers to their list. They will not apply the rudiments of business methods to their shop. To them, ten dollars intake minus five dollars outgo equals five dollars profit for the day and that's all there is to it. They become blinded by the temporary rush of business today and fail to provide for the dull season of tomorrow. They carry but few replacement parts in stock because they do not have adequate capital or credit to do so. It is a hand to mouth existence at best.

If I sound like a weeping Willie, or you, as a serviceman, wish to take issue with me, it is probably because you are one of the few who are succeeding because you *are not following the pack*.

How many servicemen keep a clean, neat, nicely decorated shop? How many have the barest essential test instruments and other shop equipment? How many keep any records of their financial position? How many could get a loan at the local bank? How many consistently advertise using any medium whatsoever? How many plan a cohesive service sales campaign? How many ring a doorbell "cold turkey" or effectively use that finest of contacts with their customers—the telephone?

If chain radio repairing presents itself, there will be no financial sales or technical difficulties which modern business methods could not overcome.

Let me take you on a tour of one of these possible businesses of tomorrow. It is located in a large American city, for it is here that the chain will first emerge. Small towns and rural areas will have their "associate" members who will be backed by the parent organization so long as they follow rules and regulations and will be as quickly booted out upon their infraction.

We enter a branch office of this concern—there is one branch for every so many thousand radio sets—and find a pleasant reception room with easy chairs, soft music and quiet, though tasteful, decorations. Our request for radio service is received by a well-mannered middle aged gentleman who fills out a report as fully as our answers to his well directed questions will permit. He then asks us to make a definite appointment at which time the radio representative will call upon us. These representatives are not just the average run of servicemen, but sales-minded radio technicians who have been specially trained to meet the public and to sell radio service.

The representative calls at the appointed hour, checks the aerial and house supply system and, after ascer-

(Continued on page 64)

## FOR IMMEDIATE RELEASE...

**Hot & Spot News will be found in this column every month. Don't fail to read it!**

Statement on the National Election  
By Philip D. Reed, Chairman  
of the Board, General Electric Co.

**T**HE election is over; the results are known. Whether our preference was for Mr. Roosevelt or Mr. Wilkie, we Americans know that the future of our country depends not on politics but on economics and national unity. The next four years bid fair to be the most critical and difficult ones within memory of living man. Profound wisdom, steadiness and vision will be needed to guide America through this war-torn world, preserving at once our integrity and ideals as a great democracy, and exerting at the proper time and place the full weight of our power and leadership toward a realistic, economic and therefore lasting world peace.

And in the meantime the creation of an impregnable defense, the training of millions of men, and the building of millions in war machines is itself a Herculean task—especially so when we recognize that the production of everyday useful goods must go on and up if we are to preserve our standard of living and avoid a wartime boom.

Add to this the task of maintaining a united, confident and understanding people awake to the gravity of our problems, ready to serve and, if need be, to sacrifice in their country's interest, and we get some notion of the nature and enormity of the burden that yesterday's election placed upon the shoulders of our President. He will need the help of every loyal American. Let us all stand by.

**A**S compact as a movie sound camera and just as easy to operate, the latest *DuMont* portable television equipment is certain to extend the range of television program material by encouraging many more outside pickups. Indeed, the entire pickup equipment, exclusive of the ultra-high-frequency relay transmitter and transmitter power supplies, comprises the camera and seven units which can be readily carried in any sedan automobile. Thus television reporting assumes a new simplicity which is bound to be reflected in future programs.

The *DuMont* camera is of the iconoscope type. The image is focused by means of an  $f:2.5 \ 9\frac{1}{4}$ " focal-length lens on the mosaic screen of the iconoscope tube. The camera contains the preamplifier for building up the video signals which are passed through a heavy shielded coaxial cable to the separate intermediate amplifier unit. Measuring  $8\frac{3}{4} \times 26 \times 16\frac{1}{2}$ " over-all, the camera weighs but 45 lbs. It is mounted on a sturdy movie tripod and can be swung instantly in any direction.

The camera power supply unit provides all required potentials with the exception of scanning signals, for the camera tube and the video preamplifier. This unit measures  $9 \times 17 \times 10$  inches, and weighs 45 lbs. The intermediate amplifier and iconoscope scanning-voltage generator unit operates as a video intermediate amplifier and also generates scanning voltages necessary for operation of the iconoscope camera. It measures  $14\frac{1}{2} \times 20 \times 8$  inches, and weighs 37 lbs.

The power supply for the intermediate amplifier and the scanning unit is still another separate unit, weighing 52 lbs. and of the same size as the camera power supply.

**A**CCORDING to W. C. Bridges, manager of the *Head of the Lakes Broadcasting Co.*, Duluth, operators at W9XYH, "Public acceptance of frequency modulation (FM) broadcasting in this locality has exceeded ex-

pectations. Listeners equipped with FM receivers are very enthusiastic over the high fidelity performance of FM. It is our opinion that the listening public needs only a demonstration of FM to completely sell them on the noise-free, high-fidelity advantages of this new system."

W9XYH, one of the first FM stations to go on the air and the first west of Chicago, has been broadcasting for more than seven months, utilizing a 250-watt *General Electric FM transmitter*. Perfect reception, obtainable day and night, is reported some 40 miles south of the station while two nearby amplitude modulation (AM) stations cannot even be heard there. The station has also been heard in the Mesabi Iron Range, some sixty miles north of Duluth.

**S**TEWART-WARNER CORPORATION and subsidiary companies reported third quarter earnings of \$317,439. Earnings for the nine month period amounted to \$994,684 equivalent to \$0.80 per share. This compares with earnings for the same period of 1939 of \$256,209, or \$0.21 per share.

The Corporation has made provision for excess profits taxes and increased normal taxes under the provisions of the Second Revenue Act of 1940.

The provision for U. S. and Canadian income and excess profits taxes amounted to \$514,637.

**P**REPARATION for the radio serviceman's red letter day (March 29, 1941, when all U.S. radio frequencies above 730 kilocycles are to be re-allocated) is well under way at RCA's Tube and Equipment Division, from whence comes an informative booklet being supplied to 100,000 radio servicemen and dealers.

Entitled "Radio's Moving Day," the booklet outlines what RCA is doing to assist radio servicemen to take full advantage of the opportunity to get into 10,000,000 homes to re-set automatic push-button receiver controls—and to sell such other things as complete check-up, alignment, new tubes, new antenna, a second receiver, and many other accessories and services they are in a position to offer.

Announcement is made that RCA will make available special test instruments to make push-button re-alignment easier—instruments which may be checked against local stations so that the resetting job may be done quickly whether the stations are on the air or not.

**T**HE TURNER COMPANY announces that it is now licensed to manufacture vibrators for car and other portable radios under James Patents No. 1,940,496 and No. 2,113,726 and other patents pending.

Turner was in production and ready to make delivery January 1, 1941.

**F**URTHER refinement and improvement of the *DuMont* delay- or memory-screen television tube has resulted in correcting the color from the original orange to a satisfactory white. The white-delay tube, which makes feasible the halving of the usual 30 frames per second to 15, thereby permitting 625-line scanning for greater pictorial detail instead of the 441-line R.M.A. standard, within the allotted television channels, has recently been demonstrated to television engineers studying various systems and standards for their subsequent recommendations to the *Federal Communications Commission*.

By providing an image-retention or carry-over effect from one electronic impression to the next, the white-delay teletron minimizes flicker. Even at 15 frames per second in-

(Continued on page 57)

# Electrolytic Condenser Leakage Tester

by **JACK D. CLEMENT, Jr.**  
Van Nuys, California

**Every serviceman and radio amateur is familiar with the annoyance caused by being unable to locate leaky electrolytics. Here is an inexpensive, but somewhat accurate leakage tester.**

**S**INCE leaky or defective filter condensers are responsible for a large percentage of set failures it is good business for the service man to be equipped with an instrument that will definitely indicate the operating efficiency of electrolytic condensers. Though there are several very good commercial testers available, unfortunately the wherewithal oftentimes is lacking.

Let's discuss the several means generally in use for testing the leakage in electrolytic condensers. Probably the most common method is the ohmmeter; and it is indeed satisfactory in the hands of the more experienced service man. It has, however, a serious drawback in that the condenser is usually tested at a voltage far lower than that at which it operates. Many condensers which show a nominally high resistance at a low voltage will reveal abnormally high leakage—even failure—at the operating voltage. It is indeed embarrassing to be called to a customer's home a few weeks after having serviced the radio to find a completely shorted filter condenser. Explanations are more or less futile when it is realized that a good condenser tester would very probably have shown the impending failure at the time the set was serviced.

Another method of testing used quite extensively is the neon lamp together with a source of direct current approximating the operating voltage of the condenser. This eliminates the main fault of the ohmmeter method and yet substitutes for it the inconvenience of accustoming one's self to the rate of speed of flashes with different values of capacity, leakage, etc.; which seems to be an unnecessary procedure in view of the fact that every service man has a universal meter of some sort, the 1 M. A. range of which provides a much more positive indication of leakage than does the neon bulb.

Which brings us to the purpose of this article: a description of a simple inexpensive electrolytic condenser tester, the majority of parts for which may be found in every service man's junk box, and yet which gives a positive meter indication of worth based on manufacturer's recommendations that an electrolytic condenser with a leakage of more than one milliamper per microfarad is unfit for use. Nothing novel is claimed for this method of testing, in fact more than one com-

mercial tester utilizes some variation of this principle, but it does seem that it should be used more extensively among service men than it is at present.

No constructional data will be given, inasmuch as most service men will prefer to utilize the materials they have at hand. The basic circuit shown in Fig. 1 will be seen to consist of a simple source of 350 volts d.c., several meter shunts and a series protective resistor (R2). Of course the meter may be directly incorporated in the instrument if desired, but most service men will probably prefer to run leads to an external meter which may most conveniently be their universal meter adjusted to the 1 ma. range.

If shunts are wound so that the following ranges are obtained it will be seen that with the proper setting of the shunt switch any meter deflection higher than one-half full scale indicates a faulty condenser.

- 1 mfd. . . . . Shunt meter to read 2 ma., full scale.
- 2 mfd. . . . . Shunt meter to read 4 ma., full scale.
- 4 mfd. . . . . Shunt meter to read 8 ma., full scale.
- 8 mfd. . . . . Shunt meter to read 16 ma., full scale.
- 10 mfd. . . . . Shunt meter to read 20 ma., full scale.

Of course, any additional ranges desired may be provided for. The sum of the shunt resistors R3, R4, R5, R6, R7, R8, should be equal to the internal resistance of the meter, which value may be found by shunting a variable resistor across the meter and measuring the resistance necessary to reduce the deflection from full to half scale. The values for each individual shunt are obtained from the formula:

$$R_s = \frac{(R_M)(I_M)}{I - I_M}$$

Where:

- R<sub>s</sub> = Shunt Resistance;
- R<sub>M</sub> = Meter Resistance;
- I<sub>M</sub> = Meter Current (full scale);
- I = Desired Meter Current (full scale)

As an illustration, the following values of shunts would be suitable for a 0-1 ma., whose internal resistance is 100 ohms:

- R3 . . . . . 66.7 ohms
- R4 . . . . . 19.0 ohms
- R5 . . . . . 5.2 ohms
- R6 . . . . . 2.44 ohms

- R7 . . . . . 1.40 ohms
- R8 . . . . . 5.26 ohms

R3 is most easily made by removing wire from a 100-ohm resistor. The others are wound with nichrome wire, or any other resistance wire at hand. For more complete data on the construction of shunts the reader is referred to a very comprehensive article by Stephan J. Varnecky in February, 1940, RADIO NEWS.

The purpose of resistor R2 is to protect the meter from the initial surge of current and from condensers with an abnormally high leakage that would otherwise throw the meter off scale. When the current is deemed to have reached a safe value, R2 is shorted out by the switch S1 and the reading taken. An equally satisfactory way of accomplishing the same result would be to incorporate an extra shunt to make the meter read 100 ma. full scale and to test every condenser on this range before proceeding further. Many other modifications will suggest themselves, including a tap on the bleeder to reduce the voltage to about 200 volts for testing 250-volt electrolytics.

It will be noticed that an extra 6-volt winding is shown on the power transformer. This will be useful in case it is decided to add a simple bridge circuit for determining unknown capacities; and it may well prove a very handy gadget to have around. Owners of the well-known Thordarson Condenser Capacity-Leakage tester may add the above described meter leakage tester by removing the neon bulb, choke and 6-volt transformer which will provide more than the necessary space. Such an addition in the writer's instance has proved of real utility for the past two years.

-30-

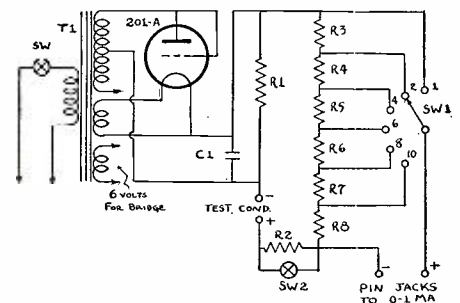

T<sub>1</sub>—Midget power trans., Thordarson  
R<sub>1</sub>—100,000 ohms, 2 w., IRC  
R<sub>2</sub>—50,000 ohms, 1 w., IRC  
R<sub>3</sub>, R<sub>4</sub>, R<sub>5</sub>, R<sub>6</sub>, R<sub>7</sub>, R<sub>8</sub>—Meter shunts  
C<sub>1</sub>—2 mfd. 400 v. paper Sprague  
S<sub>1</sub>—Single pole, 6 position switch, Mallory  
S<sub>2</sub>—Self-returning SPST toggle switch

THE FIRST REAL MOVE TOWARD CONTROL STANDARDIZATION

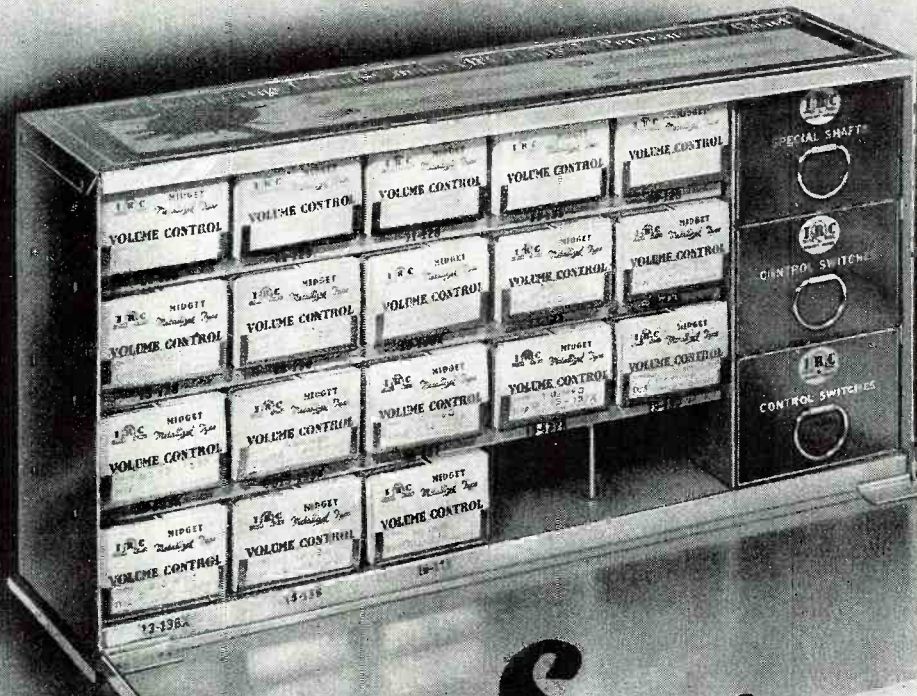

Closed view  
of cabinet

# Save TIME... MONEY... EFFORT

on Volume Control Replacements

- ✓ Reduce your stock and your investment.
- ✓ Have the control you need—when you need it.
- ✓ Simplify installations, speed up work, give customers faster, better, more efficient service.
- ✓ Avoid frequent need for more costly special replacements.
- ✓ Keep your controls systematically in a good-looking cabinet clean and free from injurious dust and dirt.

The 18 IRC Type D Universal ("All-Purpose") Volume Controls, 6 switches and 5 extra tap-in shafts of special design contained in this IRC Master Radiotrician's Cabinet handle from 60% to 75% of all volume control replacements as shown by actual IRC records! By supplementing them with a few additional IRC Type D Controls selected with a view to your own local requirements, you are in a position to handle the great majority of all replacements—from stock—at an investment so low it will amaze you!

You are equipped for better, faster service. You save time because it is no longer necessary to order a control every time you need one. You simplify installation because IRC Type D Controls with their Tap-in Shafts are easier to install and may be used universally for replacing "midgets" or larger "old-style" controls. You avoid frequent need for more costly special replacements because this Cabinet gives you a choice of 4 shaft types.

The handsome All-Metal Cabinet is included with your purchase. You pay only \$14.97, the standard net price of the 18 controls, 6 switches and 5 extra shafts with which it is factory-packed. See it at your IRC jobber's, or write for details and complete list of controls that are included. (Cabinets not sold empty.)

INTERNATIONAL RESISTANCE CO.

401 N. Broad St., Philadelphia, Pa.

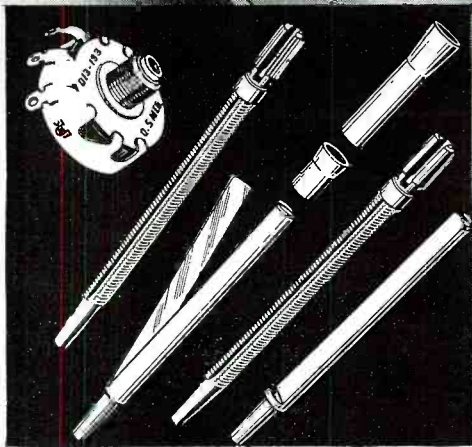

## THE FIRST REALLY "UNIVERSAL" CONTROLS

In every respect IRC Type D Controls are exact, smaller-size reproductions of the larger IRC Type C Controls. They are unique in that, although midgets, they are fully equal in quality to the larger controls. Nothing has been left out. Only the size is different, and the only change has been the addition of Tap-in Shafts which make them much easier to install in crowded chassis and far more universal in application. Simply select the control you need, tap in the proper shaft according to easy instructions and the job is done—quicker, easier and from a small stock that will represent a tremendous saving in time, money and effort to the average serviceman whether he replaces only a couple of controls a week or a couple of dozen. Type D's are small enough to fit almost anywhere; large enough for real dependability; sturdy enough to stand up under the most severe conditions.



# Type D UNIVERSAL VOLUME CONTROLS

## TECHNICAL BOOK & BULLETIN REVIEW

The new ten volume set of "Applied Electricity" just published by the *American Technical Society* is written in such form as to make it both a reference work and a complete reading course in electricity. All of the material has been brought right up to date with the view to making it invaluable for review study.

Volumes Seven and Eight are of special value to radio engineers and contain chapters on acoustics, vacuum tubes, amplifications, sending and receiving circuits, various types of rectifiers, public address systems, and a complete history and explanation of television.

Twenty-seven authors, all outstanding engineers in their respective fields, collaborated in the preparation of this comprehensive work, and thirty-two additional authorities were consulted, so that there should be no question of the value of this encyclopedia as a final authority on the subjects covered.

**THE RADIO AMATEUR'S HANDBOOK.** The 1941 edition continues the long record of comprehensive and authoritative coverage of its field—amateur short-wave radio—established by its seventeen predecessors. The field of short-wave radio knowledge has been scoured to collect all the latest and best in ideas and equipment. As always, emphasis has been placed on reliability and dependable performance, rather than novel and eccentric circuits.

The 32 chapters in the new **HANDBOOK** constitute a complete exposition of practical amateur operating and constructional data. First, there are two introductory chapters, intended for the newcomer first learning about amateur radio. There are four chapters on principles and design, covering the essential elements of radio theory in understandable fashion.

There are fourteen chapters in the construction and adjustment section, ranging from workshop practice through to the elimination of broadcast interference. In these chapters dozens of modern, proved units of high-performance amateur stations are described in detail. There is a section in which complete transmitters, laid out down to the last power connection, meter and switch are shown.

The antenna section contains five chapters alone, covering the field from basic principles to the design and construction of elaborate long-wire and rotary arrays. The ultra-high frequency section, too, contains five chapters. An entirely new section on the important subject of frequency modulation has been added.

*The Radio Amateur's Handbook*, Eighteenth (1941) Edition, by the Headquarters staff of the A.R.R.L. Published by the *American Radio Relay League, Inc.*, West Hartford, Conn. 552 pages, including 8-page topical index and 96-page catalog section of amateur radio equipment. Approximately 830 illustrations and 90 charts and tables. Price, paper bound, \$1.00

(Continued on page 63)

# MANUFACTURERS' LITERATURE

**C-D CAPACITOR.** Of special interest to servicemen, radio experimenters, hams and other users of capacitors, is a pocket-size magazine published by *Cornell-Dubilier*. Subscriptions are free and readers desiring to receive it regularly need only write to the above company at South Plainfield, New Jersey.

Indicative of the type of material offered in each issue of the "C-D Capacitor," the following brief summary of the contents of the August issue is given: A feature article discussing leakage in electrolytic capacitors, and applications which utilize this characteristic; a feature article "Servicing Push-Button Tuners"; several pages of hints and kinks under the head "Radio Service Hints" (but many of them applying to non-service work as well); and finally, "The Radio Trading Post" where readers can advertise, without cost, any parts or equipment which they may desire to buy, sell or swap. Articles and the "Radio Service Hints" department are fully illustrated with circuit drawings, etc. Free. (RADIO NEWS No. 2-100.)

**NEW TRANSMITTER GUIDE.** A new edition of the very popular transmitter Guide has just been released by the *Thordarson Electric Mfg. Co.* A wide selection of transmitters is presented, ranging from 20 to 1,000 watts, in addition to a Portable and Emergency unit and two Band Switch Exciter units.

Complete building and operating instructions are furnished, including over 100 illustrations to help build high quality transmitters of modern design. This new guide contains many new circuits and ideas on ham transmitter equipment and technical articles covering Class B Output Calculations, Driver Transformer Ratios, Matching Class C Loads to Modulators and other information of vital importance to the amateur.

It is a handy reference book to have in your ham shack; and a useful construction manual when you are thinking of changing your old equipment or contemplating the building of new units. Available at 15 cents postpaid from the *Thordarson Electric Co.*, 500 W. Huron St., Chicago, or from your local radio parts distributor. 15c. (RADIO NEWS No. 2-101.)

**ALLIED PUBLISHES NEW RADIO DICTIONARY.** As an answer to an increasing demand by radio-minded people everywhere, *Allied Radio Corporation*, Chicago, has just released a **DICTIONARY OF RADIO TERMS**. Ever since there has been general public interest in radio, there has existed the need of simple explanations of commonly used radio terms. Especially has this need been made evident from over a million letters handled annu-

ally by the Technical Staff of *Allied Radio Corporation*. This dictionary has been published as a service to the radio field and to speed the progress of beginners, experimenters and students, and to serve as a reference for advanced radio men who seek to refresh their memories on precise meanings of the more technical radio terms.

This booklet contains simple, easy-to-understand definitions of approximately 800 radio terms and abbreviations most likely to be encountered in magazine articles, books and lectures on radio and its allied fields of electronics, television and facsimile broadcasting. Schematic symbols, tips on reading circuit diagrams, instructions for using the R.M.A. Color Code, historic data and other useful historic radio information are included in this book. The dictionary is fully illustrated throughout.

This new 36-page Radio Dictionary comes in a handy 6" x 9" size and has an attractively designed cover in grey and maroon. A copy may be had by sending 10c, to cover the cost of preparation and mailing, to *Allied Radio Corporation*, 833 West Jackson Boulevard, Chicago, Illinois. 2-102.

**NEW R.C.P. CATALOG.** *Radio City Products Co., Inc.*, 88 Park Place, New York City, announce a Supplementary Catalog (No. 123) covering a number of new pieces of test equipment which have been added to their line for the 1940-41 season since the issuance of the R.C.P. Master Catalog. Included in these new items are several tube testers, all featuring the new "Rolindex" tube chart; multi-meters featuring high-speed testing; general test units; combination tube and set testers, etc. All of these instruments uphold the R.C.P. policy of ultra practical and modern equipment at economy prices.

Copies are obtainable without charge by addressing this manufacturer as above. Free. (RADIO NEWS No. 2-103.)

**SUN SOUND SYSTEMS.** *Sun Radio Co.*, 212 Fulton Street, New York City, has just released a lavishly illustrated 24-page public address booklet that should prove of interest to all in the sound field. Amongst the equipment described and illustrated are amplifiers and sound systems of every type and classification, including portable systems, mobile systems and complete indoor and outdoor installations suitable for the smallest auditorium or the largest arena or stadium. In addition, a number of pages are devoted to such P. A. accessories as microphones, speakers, pick-ups, phono motors, tuners, recorders, etc. A copy of the catalog will be gladly sent to in-

(Continued on page 66)



**Color in Television**

*(Continued from page 9)*

order: red, green blue, red green blue. But you see that the red is in front of the "A" field, green in front of the "B" field. The next time you scan the "A" field, or the odd number of lines, you have the blue filter in front of the camera, so the odd number of lines can pick up the blue which is in the picture. The next time on the "B" scan or the "B" field, we have the red screen in front of the picture so that the even number of lines can then pick up the red elements of the picture. You see the odd number of lines pick up the red here; here the even number of lines pick up the red, and the interval between the first red scan and the rest is three times 120 or 1/40th of a second. Every 1/40th of a second that you get a flash of red, the camera sees the picture through a red filter. Correspondingly, every 40th of a second you see the picture through the green, and so on for the blue.

Those flashes of color are introduced so rapidly that when they are reproduced in the same order, the eye is unable to distinguish the different flashes. They blend together on the retina of the eye and you get the effect of real color blending in the picture. Incidentally, Dr. Goldmark has so far used only colored film at his transmitter. He is not yet able to pick up outside scenes in natural color. This is so primarily for lack of light. A *Kodachrome* 16 mm picture film passes down continuously, not step by step, between the continuous projector and a dissector tube, or pick-up. It uses a very bright light so as to get intense illumination of the colored picture. The colored light passes from the film through a lens into the *Farnsworth* dissector-tube, which Dr. Goldmark used instead of the iconoscope. But between the film and the pick-up tube is a color disk which is shown in the photograph in cross section. It is pivoted to a shaft carrying a gear which is driven by a smaller gear which, in turn, is driven by an 1,800 RPM motor, thirty revs per sec. This gear re-

duces the speed to 1,200 revs per sec., so that at any one instant there is a red picture, then a green, then a blue, thrown through the lens onto the photo-electric surface of the dissector-tube.

It is not necessary here to go into the details of the *Farnsworth* dissector-tube. I believe you are somewhat familiar with how it works and how it differs from the iconoscope of *RCA*;

the dissector interprets the picture into electrons, one electron impulse after the other, one element of the picture after the other, as the cathode beam is swept up and down over the sensitive electro-emissive surface.

The output of the dissector tube passes into the grid of the video amplifier which is indicated in the box drawing. The last plate of the amplifier leads to the transmission line. This



RATING	
Fil. volts	2.5
Fil. Amp.	5
Max. inverse peak plate volts	10,000
Average plate amp.	0.25
Peak plate amp.	1.0

**NEW!**

**GL-866A/866**

**All the Wallop**

**of an 866A**

**at the Price of an 866**

**Completely Interchangeable**

**with Both Types...**

*Only* **\$1.50**

**An amazing new tube**

**and it's a bargain!**

See or write your G-E dealer without delay.  
General Electric, Schenectady, N. Y.

**BANDSWITCHING?**

See "Magnetic Bandswitching" by Law Bellem in *QST* for October, 1940. See your G-E dealer for those GL-807's and GL-814's.

**GENERAL ELECTRIC**

161-17

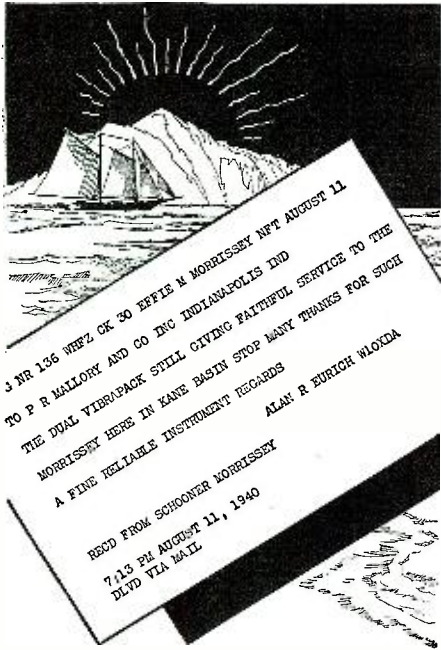

## Vibrapack

(TRADE MARK REG. U. S. PAT. OFFICE)

### Gives the Schooner MORRISSEY Perfect Service in the Arctic

The Schooner Morrissey, commanded by Captain Bartlett was almost in the shadow of the Pole when this tribute to Vibrapack was relayed.

Surely no power supply could be subjected to more rigid service. Yet in spite of ice and extreme cold, Vibrapack has unfailingly provided 100% daily service.

Even if winter in your area never brings the extreme low temperatures of the true Arctic, you'll want the long lived dependability of Vibrapack for your portable equipment . . . or any other battery operated installation requiring a source of high plate voltage. Vibrapacks are available for 6, 12 or 32 volts operation . . . with outputs up to 60 watts in the Dual Units. Write today for free booklet giving complete technical data.

**P. R. MALLORY & CO., Inc.**  
INDIANAPOLIS INDIANA  
Cable Address—PELMALLO



picture was not transmitted through the air; for the purpose of demonstration this was not necessary. The output of the video amplifier is connected to a Kinescope which was, by the way, not quite an ordinary one. It was built by the CBS engineers particularly for this work and employs an unusually high voltage. The secondary anode has 7,000 volts applied to it, the primary anode, 5,000 volts, and there are a few other distinguishing features. He obtained a very bright spot on the fluorescent screen of the kinescope. This is 9 inches in diameter. In front of that is another rotating disk carrying the color sectors arranged in the same order as at the transmitter; red, green and blue, as is shown in the diagram. Only the sectors are not triangular-shaped but of a very irregular shape, as is shown herein.

If this wheel were removed and you looked directly at the screen you would see a black and white picture. And as far as the picture as thrown on the image dissector, it might just as well be a black and white picture because electrons do not distinguish between colors. (It's a matter of indifference to the electrons whether the picture is thrown on here in red, green or blue color.) The purpose of the color screen disk is that only the parts of the picture which transmit red light are thrown through the red filter upon the photo-electric surface at one instant. And when the disk has turned to the next sector, only the light which has passed through the green portion of the color disk enters the pick-up tube and so with the next sector, only the elements of the picture which are blue in the film are transmitted as light.

So we have transmitted over the line, in succession, a series of pictures which might just as well be black and white, and would be black and white, except for the inter-position between the viewer and the screen at this end of a color disk, the colors of which correspond to the colors here at the transmitter. I think you can understand that.

At the receiver we have a larger disk than at the transmitter, the latter being 10 inches in diameter and the receiver disk measuring 20 inches in diameter made necessary, as you can see, that a colored segment covers most of the entire picture at one instant. This color disk is also driven at 1200 r.p.s., geared down by a synchronous motor which carries 6 segments so that there are 120 color segments thrown in front of the tube every second.

The colored sectors are made of colored gelatin, stretched tightly in an aluminum frame which is mounted on a shaft. The sectors are cut in such a manner that when one sector is just entering the picture field its lower edge is parallel to the frame of the picture. The line scan, as you know, begins at the top of the picture and as the scan goes down further and further to the bottom this color sector just precedes the scan, so that the lines which have just been scanned, say over one half of the picture, are observed through the green sector and then when the next segment comes in, say blue, the blue portions of the picture will be seen, etc.

The eye retains for a short interval the image of those blue lines, even though the sector itself has passed on beyond the portion which had been scanned. It is only necessary that these color sectors be always in front of the part of the picture which is being scanned, and the region of the picture immediately behind the scanning line. This disk is 20 inches in diameter, as I have said, because it has to cover this comparatively small kinescope of 9 inches diameter. The tube is not large and the picture on it is pretty small, so you can easily see the difficulties attendant on trying to use this system with a really large kinescope.

Take, for example, the 14-inch Dumont tube. This disk would then have to be at least 16 inches, nearly three feet in diameter. It would take a husky motor to turn that disk at 20 r.p.s. This is one of the fundamental drawbacks of this whole scene of color television.

At the transmitter this is not so serious as you are working from a small picture film, either 16 or 35 mm, and we don't care how much machinery or noise it makes at the transmitter so long as the noise is not picked up by the microphones. Or we can do as they do in motion picture studios; use a "blimp" and suppress the noise. But in a home it is a different proposition because at the present time it would require a large disc and a good-sized motor.

In these demonstrations the motor, the gear and the rush of the wind from this large disk revolving 20 times per second created quite a considerable noise. This was a distinct drawback, although the engineers present did not mind this because the wonder of getting a television picture in color. But that is one feature that must be reckoned with and must be overcome before color television can be a popular success.

Incidentally, it is essential that both transmitter and receiver color disks are synchronized. The two motors in the above photograph are connected to the same 60-cycle main and, of course, synchronization was very easy. But if, as in some cities, there are two different types of current used, it would be necessary to first transmit a synchronizing signal and bring in that synchronizing system at the receiver, amplify it and cause it to control the receiver motor. It is necessary that when a green sector is before the transmitter tube, the green sector be in front of the picture tube otherwise it would be impossible to get the correct color effects at all. The two disks must rotate in perfect synchronism and the colors in the two disks must correspond exactly.

Also, in getting the television color picture, you are sacrificing detail. You reduce the number of lines from 441 to 343. But you are more than making up for it in the contrast that you get by color which you cannot get in black and white. There is less resolution than in black and white but the addition of color more than compensates. Color also adds to contrast and gives information not otherwise conveyed except by color. (Turn to page 44)

# BUY DIRECT FROM THE MANUFACTURER AND SAVE

WE KNOW OUR PRICES ARE VERY LOW and expect a certain amount of skepticism from servicemen who have never purchased the SUPERIOR way, but five years of sticking to our way of doing business has convinced us and many thousands of servicemen who have purchased from us that it is a practical and mutually profitable way of doing business. We know that the average income of the Radio Serviceman prohibits his purchasing high-priced equipment, and yet the very nature of his work makes it necessary for him to use accurate, dependable and up-to-date equipment. We know we have solved the problem for him and our continually expanding business proves that servicemen recognize this claim to be true.

BESIDES THE THOUSANDS OF SERVICEMEN AND TECHNICIANS, THE FOLLOWING WELL-KNOWN NAMES ARE LISTED AMONG SUPERIOR INSTRUMENT PURCHASERS: Standard Oil Company of New Jersey; U. S. Dept. of Agriculture; U. S. Dept. of Commerce; U. S. War Department; C.C.C. Camps; National Youth Administration; Goodyear Tire and Rubber Co.; E. I. duPont de Nemours & Co.; University of Nebraska; Leland Stanford Junior University; Westminster College; Oberlin College; University of Michigan; Boston College; Pomona College; Board of Education, Remus, Michigan; Board of Education, City of New York; Board of Vocational Education, State of Illinois; City of Bartow, Florida; Florida State Dept. of Education; Educational Dept., Custer, North Dakota.



## The New Model 1220 POCKET LABORATORY

- ★ WEIGHS ONLY 28 OUNCES!!
- ★ USES a 2% ACCURATE 0-200 MICROAMMETER—ENABLING MEASUREMENTS AT

**5000 OHMS PER VOLT SPECIFICATIONS**

- ★ 6 D.C. Voltage Ranges: 0-3-10-50-250-500-5,000 volts.
- ★ 3 A.C. Voltage Ranges: 0-15-150-1500 volts.
- ★ 4 Resistance Ranges: 0-3000 ohms, with 15 ohm center, direct reading to 0.2 ohm; foregoing base range multiplied by 10, by 100 and by 1,000, to read up to 3 Meg. with self-contained 3 V. flashlight battery.
- ★ D.C. Current Ranges: 0-200 microamperes; 0-2-20-200 Milliamperes, using wire-wound shunts.
- ★ 3 Output Meter Ranges: Same as A.C. Voltage Ranges.
- ★ 3 Decibel Ranges: From -2 to +58 D.B., based on .006 watt in 500 ohms.

Model 1220 comes complete with cover, self-contained battery, test leads and instructions. **ONLY \$10.45**

## The New Model 1240 TUBE TESTER

Instantaneous snap switches reduce actual testing time to absolute minimum. Tests all tubes 1.4 to 117 volts.

Sockets for all tubes—No adapters. SPECIFICATIONS:

- ★ Tests all tubes, 1.4 to 117 volts, including 4, 5, 6, 7, 7L, octals, loctals, Bantam, Jr., Peanut, single ended, floating filament, Mercury V a p o r Rectifiers, the new S series, in fact every tube designed to date.
- ★ Spare socket included on front panel for any future tubes.
- ★ Tests by the well-established emission method for tube quality, directly read on the GOOD ? BAD scale of the meter.
- ★ Jewel protected neon.
- ★ Tests shorts and leakages up to 2 megohms in all tubes.
- ★ Tests leakages and shorts in all elements AGAINST all elements in all tubes.
- ★ Tests BOTH plates in rectifiers.
- ★ Tests individual sections such as diodes, triodes, pentodes, etc., in multi-purpose tubes.
- ★ Latest type voltage regulator.
- ★ Features an attractive etched aluminum panel.
- ★ Works on 90 to 125 volts 60 cycles A.C.
- ★ Model 1240 comes complete with instructions and tabular data for every known type of receiving tube. Shipping weight 12 pounds. Size 6" x 7 1/2" x 10 3/4".

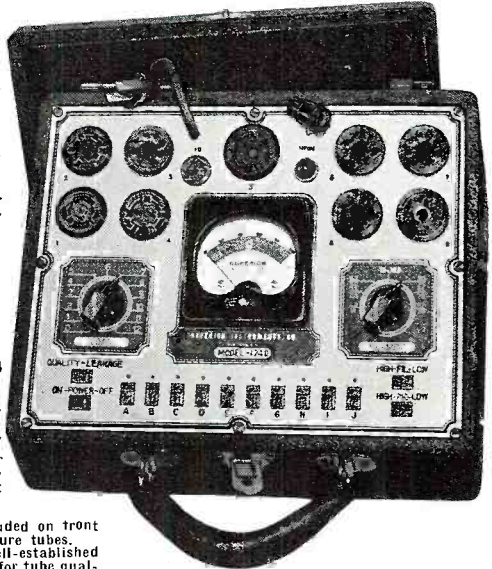

Our Net Price. **\$11.85**  
PORTABLE COVER \$1.00 ADDITIONAL

## THE NEW CHANNEL-ANALYZER

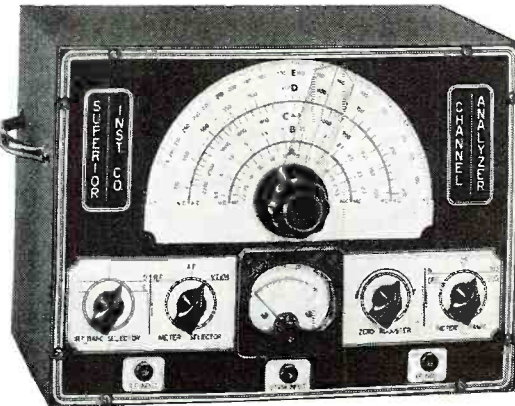

FOLLOWS THE SIGNAL

FROM ANTENNA TO SPEAKER OF ANY SET

The well-established and authentic SIGNAL TRACING METHOD of locating the very circuit in which there is trouble, and the very component that causes the trouble, is now for the first time available at a price any radio serviceman can afford.

## THE CHANNEL-ANALYZER WILL

- ★ Follow the signal from antenna to speaker through all stages of any receiver ever made.
- ★ Instantly track down exact cause of intermittent operation.
- ★ Measure both Automatic-Volume-Control and Automatic-Frequency-Control, voltages and circuits without appreciably loading the circuit, using built-in highly sensitive Vacuum-Tube Voltmeter.
- ★ Check exact gain of every individual stage in receiver.
- ★ Track down and locate cause of distortion in R.F., I.F., and A.F. amplifier.
- ★ Check exact operating voltage of each tube.
- ★ Locate leaky condensers and all high-resistance shorts, also show opens.
- ★ Measure exact frequencies, amount of drift and comparative output of oscillators in superhets.
- ★ Track down exact cause of noise.

The Superior Channel-Analyzer comes housed in shielded cabinet and features an attractive etched aluminum panel. Supplied complete with tubes, three specially engineered shielded input cables, each identified as to its purpose. Also full operating instructions. Size 13" x 10" x 6". Shipping weight 19 pounds. Only... **\$19.75**

## MODEL 1230 SIGNAL GENERATOR



WITH FIVE STEPS OF SINE-WAVE AUDIO

### SPECIFICATIONS:

1. Combination R.F. and A.F. Signal Generator, R.F.—100 K.C. to 90 Megacycles, A.F.—200 to 7500 cycles; Sine Wave, WITH OUTPUT OF OVER 1 VOLT. All direct reading, all by front panel switch manipulation.
2. R.F. and A.F. output independently obtainable, alone or with A.F. (any frequency) modulating R.F.

3. Latest design full-range attenuator used for controlling either the pure or modulated R.F.
  4. Accuracy is within 1% on I.F. and broadcast bands; 2% on higher frequencies.
  5. Giant dial etched directly on front panel, using a new mechanically perfected drive for perfect vernier control.
  6. Operates on 90 to 130 V. A.C. or D.C. (any frequency).
- The Model 1230 comes complete with tubes, shielded cables, molded carrying handle and instructions. Size 14" x 6" x 11". Shipping weight 15 pounds. Only... **\$12.85**

# SUPERIOR INSTRUMENTS CO. 136 Liberty St., Dept. RN2 New York, N. Y.

# ARE YOU READY FOR TOMORROW'S OPPORTUNITIES?

**ALL I. C. S. COURSES  
INCLUDE FM AND  
TELEVISION!**



You don't have to quit your present job in order to prepare for the golden opportunities in Radio! A few hours of your leisure time each day—in the comfort of your own home—may qualify you for big earnings in this rapidly growing field! And you'll find that studying an I. C. S. Radio Course—mastering the mysteries of this science—is a thrilling adventure!

### WHAT ABOUT TOMORROW?

Just as a growing infant changes from day to day, so the infant Radio industry changes in technique and application of fundamental theory. No one knows that better than the I. C. S. Radio School staff! I. C. S. Radio Courses are constantly being revised to keep pace with new trends and developments.

Thus every one of the I.C.S. Radio Courses includes FM and Television—and is designed to prepare you to "cash in" on the profit-opportunities which these new developments are opening to *trained men*.

### \*YOUR CHOICE OF 5 COURSES!

For those who wish to secure broad, comprehensive training, I. C. S. offers a General Radio Course and a Radio Operating Course. The I. C. S. Practical Radio Servicing Course enables you to begin practice soon after you start studying—*earn as you learn!*

The Sound Technician's Course is an advanced course for the service technician. The Sound-Picture Projectionist's Course deals with operation, maintenance and repair of sound equipment such as is used in talking-picture installations.

One of these I. C. S. Radio Courses, or a combination, may fit you for bigger earnings than you ever dreamed possible!

**MAIL THIS COUPON TODAY  
FOR A BRIGHTER TOMORROW!**

INTERNATIONAL CORRESPONDENCE SCHOOLS		1891 ★ 1941
Box 8284-V, Scranton, Penna.		
Explain fully about your course in the subject marked X:		
<input type="checkbox"/> GENERAL RADIO	<input type="checkbox"/> PRACTICAL SERVICING	
<input type="checkbox"/> RADIO OPERATING	<input type="checkbox"/> SOUND TECHNICIAN	
<input type="checkbox"/> SOUND-PICTURE PROJECTIONIST		
Name.....	Age.....	
Address.....		
City..... State.....		

(Continued from page 42)

Dr. Goldmark has gone further and made another line of experiments in which he has increased the field rate from 120 per second to 180 per second. This means, of course, everything must go faster; the disk at both ends must travel correspondingly faster, 180 sectors per second instead of 120. When he has that arrangement he uses a four-to-one interlace. By doing this he gets away even more from the flicker tendency than you do with the two-to-one standard interlace. And you find that the reduction in detail, when using 343 lines, is only 22% compared with the 441-line detail. So he gains very much in detail and still has his three colors, and still stays within the 4.5 megacycle frequency band.

But as against all those advantages are these disadvantages. The light used on the picture must be much greater. You can easily see that when the red sector is in front of the picture you are rejecting all your blues and all the greens. That represents so much light that doesn't get into the pick-up at all. So that if, in a certain picture, there was an equal amount of red, green and blue detail, you can see how, for any one picture you are only getting one-third of the total amount of light. And that means that you will get a correspondingly reduced amount of volume control of the cathode beam at the transmitter. Also you would get only one-third of the amount of contrast on the fluorescent screen at the receiver which would mean one-third of the translated visible light. In addition, that light has to pass through a colored filter which also absorbs it. The result is that we lose about 70% of the light that a black and white picture presents between the pick-up and the viewing screen. To make up for this great loss of light to a certain extent, high voltages are used on the kinescope so that a bright picture is seen on the screen.

Now in order to get live scene pickups instead of depending on films, the engineers must greatly increase the sensitivity of the pick-up device. And for that reason Dr. Goldmark proposes to abandon the *Farnsworth* Dissector Tube and go to the most refined form of the iconoscope, the Orthocron, the supersensitive iconoscope which has recently been developed by the *RCA* engineers. That would go a far way toward enabling color television to pick up live scenes.

There are any number of colored television schemes that have been proposed; a large number of patents have been taken out on various ingenious arrangements. Some of them are ridiculous and others offer considerable promise. One of these has shown this serious disadvantage—it is a three-channel system and the *FCC* so far has not licensed any transmission experimentation with this system. It would require practically three times six megacycles. In other words, where they allot seven channels in the city of Los Angeles, they would have to give three of these to one station for television in color. Of course, they are not ready to do that, although when they get to the G group of channels where the frequencies are of the order of 150 to 200 megacycles they might consent to consolidate three of those together for this purpose. Then

we can look forward to a considerable improvement in color television.

Of course, if expense is taken into consideration, this last scheme is much more expensive than the *CBS* system. It will require three different iconoscopes, one for each of the colors, red, blue and green, a video amplifier for each iconoscope and each one is connected in turn to its own radio frequency transmitter. There must be three distinct channels through the ether, each using a different frequency. These three messages go through the ether and are picked up at the receiver by three independent antennae which can be fastened to the same mounting. There the three signals are led to its own radio frequency amplifiers—to the output of each is connected a kinescope. And by a very simple arrangement of prisms and lenses we can superimpose those three fragmentary pictures on a common translucent screen.

Thus we have the three color projected composite. There is nothing moving but the cathode beams which gets us away at once from the nuisance of the colored discs and the necessity of synchronizing those discs. Also larger tubes can be used. But you can see that the cost of the receiver is here multiplied almost three times.

These systems are not the last word by any means. I don't venture to say what will be the final solution, but you can be sure that we are going to have color television before a great many years. I believe that the solution is going to lie along the line of synchronizing the color screen of transmitter and receiver, but in some other way than the whirling disc which must be more than twice the diameter of the cathode ray tube. If we have a very small projection tube, say three inches in diameter, and a very brilliant picture, bright enough so you can project it through the lense onto a screen in the room, then it would be very simple to have a little color disc like that here described, driven by a little motor of fractional horsepower, all inside of a cabinet which is lined with sealotex or felt so there is practically no noise emerging from it. When we get this projection tube it will solve a great many difficulties that now look serious. That is the line that I would like to see television engineers concentrate on more than anything else—to get a good projection tube with reasonable voltage. We might use 5, 7 or even 10,000 volts, although the last is problematic. Seven thousand volts, yes. And I believe projection tubes can be built (we don't know how at the present time) that will give you a very bright picture on, say, 7,000 anode volts. The quicker this is discovered, the quicker we will have large screen television picture projection.

—30—

### What's New in Radio

(Continued from page 29)

quality rig to go on the air. Kits consist of a 20 Watt CW Beginners Transmitter, 35 Watt Phone or CW unit, 12 Watt Universal for portable and emergency service, 55 Watt Phone-80 Watt CW unit, 12 Watt Mobile Transmitter for operation on 5 and 10 meter bands, and a 50 Watt 5 and 10 Meter Phone Transmitter.

Ask your radio parts distributor today for free bulletin SD-464, completely illustrating and describing these fine units, or write *Thoradson Electric Mfg. Company*, 500 West Huron St., Chicago, Ill.

—30—

**Electronic Maintenance**

*(Continued from page 32)*

was applied to a certain communication receiver. After a thorough examination all components, where resistance and voltage could be measured, were found intact, yet the receiver did not work. A supplementary test with a signal source fed in at various points also showed what was accepted as normal operation. It was only after signal tracing was applied, with the signal fed in at the antenna, that the defect was found to be within the winding which coupled to the crystal filter. . . . But we are straying from the normal sequence and that we do not wish to do, as interesting as it may be to speak about experiences with signal tracing.

So much for the systems ahead of the demodulator in these special service receivers. It is of course possible to describe in minute detail the exact circuit structure of these various receivers and show the presence of those units which do not appear in the regular run of broadcast receivers. But we do not think that it is necessary to point a picture which needs not exist, to build ogres where they are not. Admittedly we have left out certain details in these receivers, as for examples the manner of operation of direction findings systems, the arrangement of plug connections, the types of audio systems and noise silencing units, the vibrator type power supply and the generator types of power supply, etc. The power supply, noise silencing system, and audio circuits will be discussed next month in conjunction with equipment of audio nature.

We are saving the complete picture of the receiver until the last two installments at which time we shall set up on each of the receivers used in private aircraft operations, private marine and police work and then put them through their paces with the complete service bench and a complete detailed resume of every operation carried out. That if we may anticipate is going to be fun.

We have not said much about the application of electronics in industry in

this installment because signal tracing is limited pretty much to audio work in the majority of electronic industrial systems, or at least to such arrangements where resonant circuits operative above the audio range are not abundant. Here and there, we find devices which employ oscillators operating above the audio frequency range and wherever such circuits do exist, their testing is within the province of the signal tracing apparatus we have presented in this issue.

In connection with the signal tracing equipment, we must advise that while the complementary unit is not

**EASY TO LEARN CODE**

It is easy to learn or increase speed with an Instructograph Code Teacher. Affords the quickest and most practical method yet developed. Available tapes from beginner's alphabet to typical messages on all subjects. Speed range 5 to 40 WPM. Always ready—no QRM.

**MACHINES FOR RENT OR SALE**

The Instructograph Code Teacher literally takes the place of an operator-instructor and enables anyone to learn and master code without further assistance. Thousands have used and endorse the Instructograph System. Write today for full particulars and convenient payment and rental plans.



**INSTRUCTOGRAPH COMPANY**

Dept. NR, 4701 Sheridan Rd., Chicago, Ill.  
 Representatives for Canada: Radio College of Canada, 54 Bloor St. West., Toronto.

*Proved* **DOLLAR VALUE!**

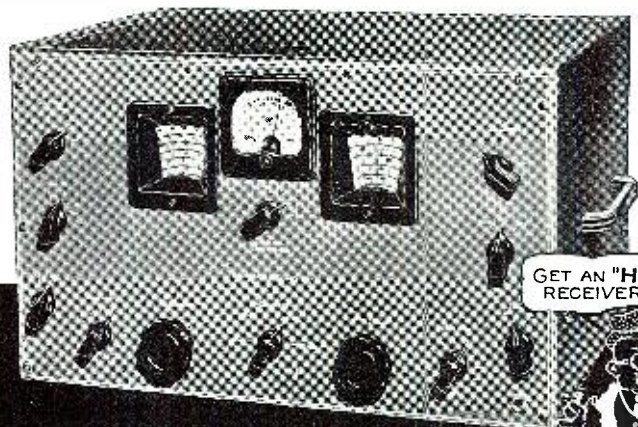

**"HQ-120-X"**

GET AN "HQ" NOW AND YOUR RECEIVER WORRIES WILL BE OVER!



HOW does it perform? How will it stand up? and, how soon will it be obsolete? These are all important questions in determining the actual value of any product. The "HQ-120-X" has established a record which answers all of these questions and assures the amateur of the finest dollar for dollar value. Many owners write that the "HQ" outperforms anything they have ever owned. Its ability to "stand up" is proved by the exceptionally few used "HQ" receivers on the market, despite the thousands which have been sold since the "HQ-120-X" was first introduced. As a matter of fact, we know of

hams who bought other makes last year in preference to the "HQ" but, who this year, traded them in on the "HQ-120-X"—no obsolescence in that! So, if you intend buying a new receiver, by all means see and hear the "HQ-120-X." Its up to the minute performance and sound dollar value, have been proved by thousands of users.

**MAIL COUPON TODAY!**

The HAMMARLUND MFG. CO., Inc. RN-2  
 424-438 W. 33 St., N.Y. City  
 Please send "HQ" booklet  
 Name.....  
 Address.....  
 City..... State.....

Export Address:  
 100 Varick St., N.Y. City—Cable ARLAB  
 Canadian Office:  
 41 West Ave. No., Hamilton, Ont.



**HAMMARLUND**

# Every-Purpose AMPLIFIERS

This 14 watt Thordarson amplifier with booster circuit accentuating frequencies in the vicinity of 40 to 100 c.p.s. makes it possible to reproduce with truer fidelity. This unit is well qualified for sound applications. Full 14 watts output delivered at all frequencies. Model T-25W14 \$62.50  
—fourteen watts—with tubes.



Thordarson advance chassis design 20 watt model T-25W20 amplifier. Both powerful and compact. Built to withstand hard usage. Ideal for portable and rental installations. Model T-25W20. \$82.50  
Twenty Watts.....



SEE YOUR THORDARSON JOBBER TODAY  
OR WRITE FOR AMPLIFIER CATALOG

**THORDARSON**  
500 W. HURON ST., CHICAGO  
TRANSFORMER SPECIALISTS SINCE 1895

## READ AND SEND CODE

Learn Easily at Home  
This Quicker Way

No experience needed. Beginners read code quickly, copy accurately. If already an op, speed up your wpm with this approved amazing all Electric Master Telex Code Teacher. Only instrument which records your sending in visible dots and dashes on specially prepared paper tape—then sends back your own key work at any speed you wish. Fascinating, foolproof—gets results because you learn by HEARING as well as SEEING. That is why thousands agree this method is surest and quickest. While not designated standard equipment, Telex is used at many U. S. Army Posts, Naval Training Stations. We furnish Complete Course, lend you the New All Electric Master Telex, and personal instruction with a MONEY-BACK GUARANTEE. Low cost, easy terms. Write today for folder RN2, no obligation.

TELEPLEX CO., 67-69 Park Place, New York  
In Canada write:  
CANADIAN ELECTRONIC INST., TORONTO, ONT.



yet on the market, we also must state that it has passed out of the development stage and by the time that this series is finished, perhaps much sooner, it will be operating in the field among those men who have high frequency service work. We do not consider it premature to speak about it because we desire to shout to the housetops the very fact that as was stated three and a half years ago—the signal is the common denominator of all receivers and other apparatus of kindred nature, and that the first step in removing frequency as a barrier to signal tracing under all conditions has been again successfully hurdled. —30—

### Washington Communication (Continued from page 12)

stepped the bounds in its campaign against the President and wants to make sure the latter doesn't.

It is reported that he is the man who would fill the bill as a "George Creel" if we were at war—chief censor and former of opinions. Since he has no particular knowledge of or background in the radio field, his appointment to the sub-committee which would make the rules under which the ether would be used in war, lends credence to this report.

Mellett's appointment was announced quietly and attracted no particular attention. He is a behind-the-scenes worker and wanted it that way. But before this is over, the broadcasters will probably find out that Mellett's word means more than the rest of the committee's put together—including their own.

#### FM Advancing

FM is the thing in the radio field today. Within a year, insiders believe, there will be a national FM chain, and eventually, the AM systems will go the way of crystal sets and The Happiness Boys.

High F.C.C. officials believe that within a year this problem will be solved, that of setting up a chain and chain rebroadcasting, and that within a year this chain will be in operation. The fact that the F.C.C. is favoring an FM chain is not old-stuff either. It has only become apparent recently.

From the F.C.C., the FM broadcasters are getting every break. The reason, is not obvious, but simple. The F.C.C. commissioners are feuding with the big broadcasting chains, particularly NBC, because they believe the chains are monopolistic. The coming of FM stations will bring new faces and stiff competition, but some observers fear, new monopolistic threats.

FM service for the New England states, New York, part of Tennessee, Pittsburgh, and Chicago was announced with glee by the F.C.C. recently. This added 20 million potential listeners to total in the areas already serviced by static-less station.

FM engineers held a conference in Washington before Christmas to discuss standards and progress. Formation of a national hook-up has been blocked by difficulties in linking the short-range FM stations into a chain. But WDRC experiments in Hartford, Conn., over re-broadcast station W1XOJ, are reported to hold out real promise for solution.

Distinctive calls have been arranged for the FM stations. These will sound very unusual to the ears which have been accustomed to the present AM calls. The first call letter of an FM station must be a K or W, depending upon its geographical location. The second letter of an FM station will be assigned in alphabetical order, with the exception of "E", which will be reserved for non-commercial educational stations using Frequency Modulation. Between the two letters, however, will be a number consisting of two digits. These numbers will indicate the frequency assignment. This is possible because all FM stations are in the 42 to 50 m.c. bands, and because all FM frequencies are assigned on odd hundreds of kilocycles, thus the first figure and the last

two figures of the frequency assignment can be dropped. In addition, and where possible, the city or area will be indicated by the second letter, or a combination of the second and third letter. Letters combination of mnemonic character have been assigned to each of the metropolitan centers, thus stations in Boston will terminate with the letter B, or a station in New York City will terminate with NY. Similarly, stations in the District of Columbia will be identified by the suffix "DC." In brief, here is how the system works: Station W41B will indicate an FM station in the eastern section of the country, for instance, Boston, operating on a frequency of 44,100 kc. By the same token, K43SF would apply to an FM station in San Francisco operating on a frequency of 44,300 kc.

One thing the new FM station call assignment will eliminate is a certain short-wave body which has been assigning similar "numbers" to its members. Heretofore, these numbers meant nothing, but now that they are legitimately assigned to FM stations, that short-wave outfit will have to change its method of "licensing" its members.

#### F.C.C. Inquiry

THE F.C.C., by the way, is in for a good going over at the next session of Congress, your correspondent has learned. The monopoly reports scoring the big broadcasters has aroused the ire of conservative congressmen. They want to investigate the F.C.C. in reprisal. In the process, the investigators will look into the radio industry set-up, giving the whole conflict between the F.C.C. and the big chains a thorough airing. Your correspondent advises to watch for fire-works in regard to this investigation.

#### WAR Contacts

ON the first night of operation, the following stations, in the order named, were worked by WAR, the Army's big station at Arlington. The first station worked was W1AW, the ARRL headquarters. Thereafter, the following stations were worked in the order named: W3QV, W3AOC, W3EON, W3TL, W8DVC, W3ECP, W3EWK, W4PB, W3INH, W9PGL, W8NJK, W9AQ, W1LVQ, W1INC, W1EPE, W5HGL, WIKE, W1LHA, W2MHJ, W8J1W and W8PAF.

#### Defense Purchases

THE business of building radio sets for the Army goes on at the same fast pace. The Signal Corps, which used to list radio as the last means by which a message was to be sent, finds now that it must use the air first in most cases. Result, radios for almost every bit of the Army-on-wheels—and order like this batch announced last month, in Washington:

Federal Telegraph Co., Newark, \$1,370,165, for receivers and parts;  
Allen B. DuMont Laboratories, Passaic, N. J., \$226,606, for receivers;  
J. H. Bunnell & Co., Brooklyn, \$116,455, receivers;  
Aircraft Radio Corp., Boonton, N. J., (with Western Electric), \$3,960,997, receivers;  
Western Electric, Kearney, N. J., \$15,539,053, receivers;  
ERCO Radio Labs, Hempstead, N. Y., \$11,700, transmitters (for Coast Guard);  
Bendix Aviation Corp. (Baltimore and Bendix, N. J.), \$12,455,630, for receiver, tube assemblies and other parts;  
Kellogg Switchboard and Supply Co., Chicago, headsets, \$604,596;  
Connecticut Telephone and Electric Co., Meriden, Conn., \$604,596, headsets; Hammarlund Manufacturing Co., New York City, receivers, \$23,729;  
Holtzer-Cabot Electrical Co., Boston, headsets, \$57,791;  
General Electric Co., Schenectady, N. Y., \$6,460,325, transmitters;  
Forest Manufacturing Corp., Newark, N. J., rectifiers, \$19,715;  
Radio Receptor Co., New York City, transmitting equipment, \$45,272;  
RCA Mfg. Co. (Camden and Indianapolis), receivers and amplifiers, \$2,755,570;  
Farnsworth Television and Radio Corp., Fort Wayne, Indiana, receivers, \$652,189;  
Evertite Manufacturing Co., Davenport, Iowa, radio cabinets, \$32,100;  
The Daven Co., Newark, components for

remote control, \$124,396;  
 Widin Metal Goods Co., Garwood, N. J.,  
 mast sections for radio sets, \$236,000;  
 United Transformer Corp., New York  
 City, radio filters, \$107,667;  
 Square D Co., Elmhurst, N. Y., tube as-  
 semblies, \$645,000;  
 Sterling Sillman Corp., New York City,  
 10 k.v.a engine generator (Navy), \$1,999;  
 Karp Metal Products Co., Cleveland, radio  
 cabinets, \$21,704;  
 William J. Murdock Co., Chelsea, Mass.,  
 headsets, \$202,480;  
 Airplane and Marine Direction Finder  
 Corp., Clearfield, Pa., \$29,329, equipment for  
 direction finder station;  
 Horton Manufacturing Co., Bristol, Conn.,  
 mast sections for vehicular and ground radio  
 sets, \$159,251; and  
 Froiland Manufacturing Co., Springfield,  
 Mass, mast sections, \$61,527.

**UHF Shift**

**T**HE Aviation Radio sub-committee of  
 the DCB will tackle as its principal job  
 the shifting of all U. S. aircraft radio to  
 UHF. This will be accomplished by Janu-  
 ary, 1943, under present plans.

Larger airports will be using UHF by  
 July 1. During following months, the  
 smaller airports will shift over. For some  
 time, it will be necessary for commercial  
 planes to carry two kinds of equipment—  
 for the standard broadcasts and for UHF.  
 It is possible that air beacons will continue  
 on their present frequencies permanently—  
 meaning that planes may always carry dual  
 equipment.

The aviation sub-committee must see that  
 airport radio activity is co-ordinated and that  
 the frequencies assigned for this work are  
 used with utmost efficiency.

The state and municipal facilities sub-  
 committee has a somewhat similar problem.  
 They will discuss the possibility of moving  
 fire and police radio systems to FM bands.  
 Numerous inquiries are being received from  
 police, asking about the best methods of  
 proofing their systems against sabotage. This  
 sub-committee will draw up standard anti-  
 sabotage measures and will recommend es-  
 tablishment of a liaison between all state,  
 and municipal police and such Federal radio  
 nets as the F.B.I.'s. They hope to build an  
 air trap that no one can escape.

The Army Signal Corps, owner of more  
 television equipment than most people think,  
 has brought its video experiments along to  
 the point where many officers believe that an  
 extensive investment in the field is immin-  
 ent. They won't say yes or no when asked  
 whether that 200 g's contract with DuMont  
 was first step in television purchase program.  
 The Navy communications men wept when  
 F.D.R. horse-swapped those 50 ancient de-  
 stroyers to Great Britain, because all the  
 radio equipment went with them, and the  
 Navy is ever so short. The Navy is par-  
 ticular about the stuff it buys and doesn't  
 make large-scale bargains involving millions,  
 like the Army does. Their stuff is built from  
 the ground up, tested and super-tested. Re-  
 sult is, that the Navy is taking bits of equip-  
 ment off ships here and there to outfit the  
 new gunboats and auxiliaries which are pour-  
 ing into service.

**Nazi Radio-revolution?**

**T**HOSE "soft speakers" which sick peo-  
 ple tuck under their pillows so they can  
 hear the radio without disturbing anyone,  
 are causing Hitler's *gestapo* to worry them-  
 selves sick. The German *Secret Police*,  
 noting a big increase in sales suspect "un-  
 scrupulous" Nazi of listening to foreign  
 broadcasts. This, of course, is a peniten-  
 tiary offense and no one knows exactly how  
 many "soft speakers" there are in Germany.  
 It is to be hoped that the increased sale of  
 these units indicates a growing desire upon  
 the part of the people of Germany to find  
 "what it is all about."

**F.C.C.-Medico**

**A**T the F.C.C. medico meeting, which was  
 called by the Government body to de-  
 termine whether or not something could not  
 be done to counteract the interference of the  
 medicos' short-wave diathermy machines,—  
 that was the reason given,—committees were  
 appointed which will meet on January 6th.  
 The committees to look into the situation  
 have not yet been named. Your correspond-

ent is still of the opinion that the real reason  
 for calling the meeting was to discover if  
 it were not possible for the F.C.C. to control  
 the diathermy machines to eliminate their  
 possibility of being used for 5th column and  
 subversive elements activity and communica-  
 tion.

**Radioana**

**T**HE Government has not yet done any-  
 thing concerning cryptographic broad-  
 casts which were reported in last month's  
 column. There is great doubt if your col-  
 umnist will be able to report what, if any-  
 thing, the Government will ever do about  
 the situation since, obviously, it is one which  
 cannot be publicly revealed.

A recent study of foreign language broad-  
 casts reveals that a total of 199 domestic  
 radio stations now schedule broadcasts in  
 one or more foreign languages, while 57  
 additional stations, while not now broadcast-  
 ing any foreign language have done so in  
 the past six months. Thirty-one foreign

languages are represented on 1721 current  
 weekly programs, representing nearly 13 for-  
 eign language programs a week. Approxi-

**Simplest** WAY TO REPLACE  
**BALLASTS**

4 STANDARD  
 TYPES of Amperite  
 Regulators replace  
 over 200 types of  
 AC-DC Ballast Tubes now in use. . . Has  
 patented automatic starting resistor.  
 List \$1.00  
 WRITE FOR REPLACEMENT CHART "S"  
 Amperite Co. 581 Broadway, N. Y. C.

**AMPERITE**

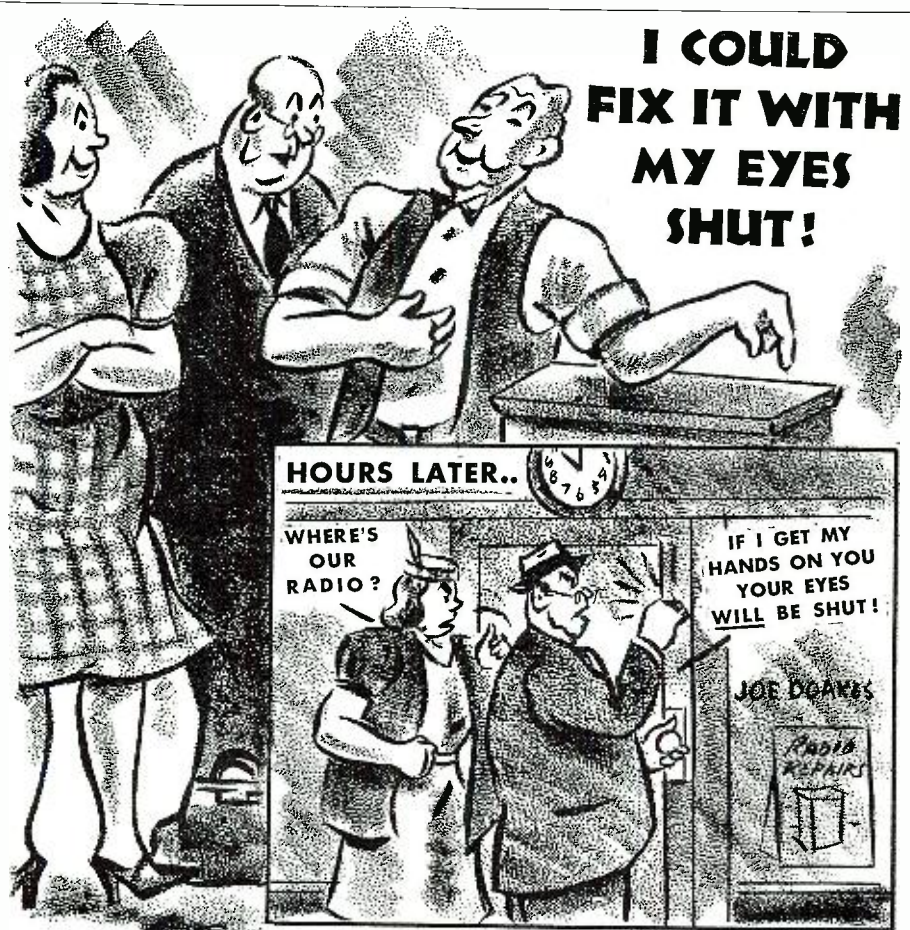

**STOP WORRYING**  
**About Broken Delivery Promises!**

**CHECK! Order Missing Volumes**

Vol.	Price	Covering	Vol.	Price	Covering
XI	\$10.00	Up to May 15, 1940	VI	\$7.50	1935-36
X	10.00	1939-40	V	7.50	1934-35
IX	10.00	1938-39	IV	7.50	1933-34
VIII	10.00	1937-38	III	7.50	1932-33
VII	10.00	1936-37	II	7.50	1931-32
			I	7.50	1920-31

Stop racing the clock. Stop working on your nerves.  
 Stop trying to "outguess" faulty receivers. **KNOW**  
 what the manufacturer puts into every set that comes  
 to your bench. Start all your jobs right—locate trou-  
 ble quickly reach for your Rider Manuals. Success-  
 ful service shops all over the world depend on them  
 for data on alignment, I-F peaks, operating voltages,  
 parts lists and value, voltage ratings of condensers,  
 wattage ratings of resistors, coil resistance data, gain  
 data, and all essential information that servicemen  
 need for quick, easy, profitable trouble shooting.

Stop being panicked by late deliveries. Be sure you  
 have all Eleven Rider Manuals.

**JOHN F. RIDER, Publisher, Inc.**

404 Fourth Avenue New York City  
 Export Division: Rocke-International Elec. Corp.  
 100 Varick St., New York City Cable: ARLAB

**You NEED RIDER MANUALS**

# Pocket Tester FOR THE AMATEUR

TRIPLET  
Model 666-H

**\$14.50**

Net Price



Size -  
3-1/16"  
x 5 7/8"  
x 2 1/2"

## 5000 VOLTS SELF-CONTAINED

Model 666-H Volt-Ohm-Milliammeter is a complete pocket size tester—with AC and DC Voltage ranges to 5000 Volts (self-contained). AC and DC Voltage at 1000 ohms per volt 0-10-50-250-1000-5000; DC Milliamperes 0-10-100-500; Resistance 0-300 ohms; shunt type circuit, 10 ohms reading at center scale; 0-250,000 ohms, series type circuit, 3700 ohms at center scale. Higher resistance measurements available by using external batteries. Selector switch for all instrument readings. The ideal Pocket Volt-Ohm-Milliammeter for amateurs, radio technicians, industrial engineers, research. Black Molded Case and Panel. Completely Insulated with RED & DOT Lifetime Guaranteed Measuring Instrument. Dealer Net Price. **\$14.50**

"For full cooperation with the National Defense Program, Triplet engineering and production facilities are being rapidly expanded to continue the service and delivery to which our trade is accustomed."

WRITE FOR CATALOG!

Section 152 Harmon Drive

THE TRIPLET ELECTRICAL INSTRUMENT CO.  
Bluffton, Ohio

RACKS  
PANELS  
CHASSIS  
CABINETS

BY

# Par-Metal

"The Line of Beauty"



Ask the man who builds his own and he'll tell you that you can depend upon Par-Metal Parts to be of easy assembly, accurately machined and interchangeable almost at will. You'll learn, too, that they are streamlined, modern in every respect and handsomely finished for lasting beauty. There are Par-Metal Parts for every job—from simple chassis to complete Sound Systems or Kilowatt Transmitters.

Our Catalog No. 40 describes and illustrates both our Deluxe and Standard Lines. Get a Free copy at your jobbers or from us direct.

**PARMETAL PRODUCTS CORP.**

3262 49th St., Long Island City, N. Y.  
Export Dept.:  
100 Varick Street, New York, N. Y.

mately three-fourths of this is in Italian, Polish, Spanish, Jewish and German languages, proportionately increasing in the order listed. Of the 199 stations, 108 have a power not in excess of 250 watts, however, a substantial number of stations, which devote a considerable amount of time to foreign language programs have greater power. There are 43 stations which broadcast 10 or more hours a week, and in one or more foreign languages. This is the result of a report requested by the *F.B.I.* to check on foreign language broadcasts in the United States. The future status of such broadcasts is still in doubt, but Attorney-General Jackson is holding out for their complete removal from the air against the *F.C.C.*, which thinks they serve an excellent purpose and can be turned to patriotic motives. . . .

A two-way short-wave police radio system has been established along the Quebec-United States border. This is the first of its type to be installed. The radio set-up will deal mostly with the exigencies of war smuggling and with gangs dealing in alcohol and narcotic traffic. . . .

The point-to-point requests, which always show which way the wind is blowing, indicate that attention should be focused on the following points in the next month: watch Greenland, Martinique, and Alaska-Russia, where *RCA* has recently requested an extension of facilities. Usually *RCA* does not request extension of facilities unless something is stirring. Remember, we told you. . . .

The *F.C.C.* has waived provision on all amateur licenses now in force until January, 1942, which would require proof of satisfactory service in connection with the renewal of the radio operators' licenses. Specifically, Section 12.26 and 12.66 have been waived, on all renewals between now and January 1, 1942. This rule applies to station licenses as well as to amateur operators' licenses. . . .

Increased activity in smaller radio manufacturing plants indicates a drive for more members by the *A. F. of L.* and the *C.I.O.* unions. At present, the greatest strength of union in the manufacturing field, is in the big companies such as *RCA*, *General Electric*, etc. It is estimated that 90% of the workers in the biggest producers belong to the union, but in the smaller companies, such as those working on parts in the sub-contracts, the unions are not as strong. Union leaders are starting a drive to increase their membership in these plants. . . .

The Army is well satisfied that it has overcome the problem of interference in tanks. Chief interference came from the motors and from static generated in the friction of tread drive wheels. A secret method has evolved to eliminate tread static, and sets are well shielded against all other kinds of noise from motors, etc. Headsets are fitted with special rubber pieces so that the roar of guns will not seriously interfere with the operator's hearing. The Army has not found *FM* to be in any way advantageous for tanks. . . .

The Army has formed, as reported previously, in the Signal Corps School, at Fort Monmouth, N. J., its first Radio Intelligence Unit. The job of this unit is the location of enemy transmitters in battle which is done by triangulation. Separate units are being organized for the purpose of intercepting enemy radio broadcasts. There will be more of these, as well as the locating of units in the standing Army. . . .

Many of the 5,000 members of the *Naval Communication Reserve* have been called to active duty. The exact number is a military secret. Experts place the number between 1,500 and 2,500. The members of this Navy net are all actually enlisted in the *Naval Reserve*. . . .

The Army amateur system operates differently. The members of this net are not actually enlisted in the *Army Reserve* and, therefore, they cannot be "called up." The Army is getting its radiomen in the Draft, while the Navy is not. . . .

The Army, by the way, is not giving any more commissions in the Reserve Corps to men of Draft age, unless they have had some prior military experience, either in the Reserve, or Regular Army, unless there is a pressing need for specialists in their field. This explains why some experienced radiomen have been turned down on their appli-

cations for commissions recently. Twenty thousand Reserve Officers who are called up shortly will all be men who were enrolled before the draft. There may be a call for men to fill their places in the Reserve later. . . .

Of primary interest to the radio industry at large is the appointment, on December 15, by the President, of an administrator to take care of the "priorities" for Army contracts. So far, priorities have not been a serious problem in the radio industry, but they may become and the administrator may have to act. In any event, we're just reporting. . . .

On December 18, Secretary of the Navy, Knox, announced the allotment of about \$20,000,000 for plant expansion to speed production of aviation and radio supplies for the Navy. Of this sum, \$2,370,034 went to the *RCA Manufacturing Company* for expansion of its plant. . . .

Amateurs are warned that the German station signed the call *D4QET* is attempting to contact United States amateurs. The purpose of the contact sought by *D4QET* is not well known, but under no circumstances, aside from the fact that it is illegal, should any American amateur answer the call or return to QSO with this station, should he, *D4QET*, answer the American amateurs' CQ. . . .

Statistics compiled by the *Institute of Radio Engineers* show that eleven million radio receivers were produced during 1940 as against 9 million for 1939. In 1940, table model receivers continued to be the most popular, accounting for 52% of the total. Automobile sets numbered 2,300,000, and altogether there were approximately 1,000 different models of radio receivers available during the year. . . .

-30-

## Serviceman's Experiences

(Continued from page 23)

people understood? Well, last month Clive delivered one on frequency modulation that was so good *nobody* understood it. After the lecture he had so many flashbulbs fired in his face he's still got a sunburn. He didn't *invent* ether, but I wouldn't be surprised if all signals came to him for an okay before they reached a receiving antenna!"

"Calm yourself," Al said. "Just remember he's called us because he wants a set repaired. Get going!"

As I drove to Clive's apartment, I reviewed some of my early theory. "*E* equals *I* times *R*," I repeated firmly. "*I* equals *E* over *R*, and *R* equals *E* over *I*." I shook as I pictured myself working on his set as he stood behind me, checking my work with two slide rules hooked in series. I was perspiring when I rang his bell.

"Come in!" someone shouted. I steeled myself and entered.

The *Great Man*, wearing a bathrobe, was seated in an easy chair. He had been reading. I was too nervous to speak.

"Radio?" he asked.

I nodded.

"Set's over there," he pointed. "I wish you'd take it to your shop to work on it—I've got to go over this stockholder's report. Have an aspirin?"

That's the last I saw of him.

When I delivered the set, he was out of town, so I gave it to the janitor. We mailed him a bill for \$13.50, and his check arrived three days later. Pinned to it was a note saying: "Thanks. You must know your business—the set sounds better than it did when it was new!" and his name was signed to it, plain as day.

Al framed the note and hung it in the front of the shop. He says he's going to point to it if I ever get another attack of buck fever.

-30-



**For the Record**

(Continued from page 4)

tubes, all of which will be active and not ballast. There will be almost everything that any short-wave listener, amateur, professional radio operator, or listening post could possibly desire from a receiver. Among other things, it will use over a hundred resistors, condensers, and thirty-seven coils—in fact, it will practically do everything except sit up and call you by name! We expect to run the first article of a series of three on this receiver, which we have called the "Radio News 1941 Super Superheterodyne" in the April issue. The second and third articles to follow in the May and June issues. At the June *Radio Show*, in Chicago, the unit will be exhibited.

While we do not expect great hoards of amateurs and experimenters to build this unit, we know that there will be a few discerning individuals who will want to have a receiver such as this. We hope to make their task light by doing all the tough work for them. At any rate, watch for the "Super Superheterodyne," starting with the April issue of *RADIO NEWS*.

**WE'D** like to give you a short report on the *Radio Minutemen of America*. They are going great guns; and some of the reports which we have received from the members indicating that they have seen or heard 5th-column activities, has made interesting reading indeed. Sorry we are that obviously we are prohibited from reveal-

ing what these reports contain; however, we did notice an unusual lack of "crack-pot" reports. Most of the members take their work seriously and are doing an outstanding and excellent job. Letters of commendation of the *R.M.M.A.* work have been received from J. Edgar Hoover, head of the *F.B.I.*, and from the head of the *Army Intelligence Department*, Washington, D. C. You may have read of some of the *R.M.M.A.* work in local or national papers without knowing the members were responsible for the news. One day we will reveal just how much of the under-cover work has been done by the *R.M.M.A.* Of one thing we would like our readers to be sure. The *Minutemen* have never usurped the work of the Government agency. They have been only reporters. It has been up to the proper Government agencies to take whatever action has been indicated.

As long as there are such public minded and public spirited citizens as those who have voluntarily given of their time and effort in the *R.M.M.A.*, there cannot be a dictator in our country. The motto of the *Minutemen* indicates their goal. They are "Dedicated to the Preservation of our Democracy." Rolls of membership are still open to any who would like to join. Drop us a postcard, and we will see that the rest is done for you.

**WE** wish to call attention to the superb illustrations appearing in Technical Editor Oliver Read's article on Recording this month. Not only are the photographs unusual from the standpoint that they have never been before shown with such completeness,

but they also indicate that a record, plus a light, can and does take the place of a chart. As Mr. Read explained to us, by using the illustration as an example of what to do, and duplicating it at home, one has a complete graph of the possibility of his recorder. While the making of the photograph is difficult, anyone can run a test record, and by placing the light at the side, he will see before him a visual indication of the frequency response of his recorder. We know from our mail that many of our readers have been following Mr. Read's series on "Building Your Own Recording Studio," and that this part dealing with frequency response will be a most welcome and sought after addition.

**AN** open letter to all broadcast chains and stations:

Dear Mr. Broadcaster: We hope that you are aware of the fact that Uncle Sam is spending thousands of dollars in teaching his draftees radio. We know that you are aware of the fact that there are over 50,000 licensed amateurs. Of this number, some 5,000 of them are in Naval Communications Reserve, and 2,500 of them have been called to the colors. The Army has its amateur radio system, numbering in excess of 3,000 operators. Schools are booming from Coast to Coast and from Canada to Mexico. All this to train operators and to keep those who are trained up to snuff. But what are you doing to help the situation? The *ARL*, it is alleged, has made representations to the *Federal Communication Commission* looking towards an increase of amateur operators so that if these representations are followed,



## GREAT NEWS!!—THE NEW UTILITY TESTER

The Utility Tester is a new kind of instrument for testing all electrical appliances—WASHERS, IRONERS, REFRIGERATORS, RANGES, VACUUM-CLEANERS, TOASTERS, PERCOLATORS, HEATERS, SUN LAMPS, AIR-CONDITIONING, MOTORS, etc. The Utility Tester enables every possible measurement necessary to service any electrical appliance.

Mr. Radio Serviceman, here is a new source of revenue for you. The UTILITY TESTER will enable you to accept and economically service electrical and industrial jobs you have been compelled to pass up in the past. You already possess the fundamental electrical knowledge necessary to service electrical and industrial utilities, and now you can have the instrument which will enable you to apply this knowledge to a new and lucrative source of extra income.

**SPECIFICATIONS:**

**3 WATTAGE RANGES; A.C. AND D.C.**  
0-100 Watts 0-1000 Watts 0-5000 Watts.

The UTILITY TESTER reads the actual wattage consumption of any appliance, motor, etc., while it is in operation. Thus you can actually prove to the layman the actual consumption of any appliance and compute the actual cost per hour operation, basing your calculation on the local current cost. This is a feature never before obtainable in any instrument selling for less than \$50.

**6 VOLTAGE RANGES; A.C. AND D.C.**  
0-1 Volt 0-10 Volts 0-50 Volts 0-100 Volts 0-500 Volts 0-1000 Volts.

**4 CURRENT RANGES; A.C. AND D.C.**  
0-1 Ampere 0-10 Amperes 0-50 Amperes 0-100 Amperes.

As far as we know no instrument selling for less than \$50.00 has ever enabled current measurements up to 100 Amperes. The UTILITY TESTER provides this service on both A.C. and D.C.

**2 RESISTANCE RANGES:**  
0-300 Ohms 0-3000 Ohms.

The UTILITY TESTER reads all resistances commonly used in electrical appliances and in addition reads extremely low resistances. For instance, 1½ ohms appears on the center of the low ohms scale and resistances as low as 1/50th of an ohm are easily read. This is a feature never before obtainable in an instrument selling for less than \$50.

The Utility Tester comes complete with self-contained battery test leads, and all necessary instructions. Shipping Weight 11 lbs. PORTABLE COVER \$1.00 ADDITIONAL

**SUPERIOR INSTRUMENT CO., 136 Liberty St., Dept. N2, New York, N. Y.**

ONLY  
**\$10.85**

*The New*  
**TURNER**  
**Magnetic Pick-Up**  
 gives immense volume to  
 any stringed instrument



Model  
MM

Built-In  
Volume Control

Offers tremendous performance without feedback. Novel clamp fastens unit to violin, guitar, etc., without use of tools or adhesives. High impedance-works directly to the grid. Withstands severe use. Rich brown enamel finish. Is 3 1/4" long by 1 5/16" wide. Model MM complete with 25 ft. cable. List \$29.50

**A Turner Classic  
99 DYNAMIC**

First choice of professionals, and demanded by manufacturers for their finest equipment. The toughest, most reliable and efficient mike in the entire Turner line. The biggest value your mike money can buy. Model 99, List \$29.50



Write for Free  
Information on All Models

**The TURNER Co.**  
 908 17th St. N. E., Cedar Rapids, Iowa  
 Crystals Licensed Under Patents of  
 The Brush Development Co.

there should be an additional 75,000 radiomen within a short space of time; and yet you have consistently failed to take notice of the extremely valuable adjunct to our Government in time of emergency and in peace—the American Radio Ham.

It has been requested from time to time of you to promulgate and push a radio program directed to the amateurs, and to students learning radio, to help in their acquiring the public spirit which moves these men and women, youngsters and oldsters alike, to spend their own money in furthering a hobby which may, and probably will, be of invaluable aid to this government.

When will you decide to do something to aid this group which is well worth while? Surely it is entitled to as much interest on your part as are the followers of the race tracks (and you do give out race track information). Surely this group is entitled to as much air-time as you would give the followers of serious music (and you do broadcast concerts). Surely this group is as valuable to the country as are cooking schools (and you do broadcast recipes).

We urge upon you most sincerely that you give the amateur a break, that you devote some of your time to him (not only when there is an emergency and the amateur is your sole means of gathering information), but also in his preparedness program and in the furthering of his interests. We think that such a program, were it to be generally aired by your stations, would have a national purpose, which, at this time, should not and cannot be minimized.

Very truly yours  
 RADIO NEWS.

\* \* \*

**A** WORD to those of you who make your own records. The acetate blanks which have become increasingly popular as their price became lower, are subject to the greatest physical change in the first three months after they are manufactured. After this period, they stabilize themselves and remain somewhat constant. In order to get the best from your recordings, not only in the making of them but also in playing back, at some later date, the valuable record which you have taken such pains to record, it is necessary that these blanks be kept in metal cans sealed against rapid changes of temperature. Blanks should not be left lying around loose in cardboard boxes, or upon shelves. It will be found that if they are sealed as indicated they will not only last longer, but the recordings will have a continual brilliance which will not appreciably lessen with time.

\* \* \*

**W**E recently heard where an amateur was called in to repair an a.c.-d.c. set. Unfortunately for him, the unit was operating on 115 volts d.c. Removing the chassis from the insulating cabinet, the amateur plugged in the set to determine the cause of its breakdown. When he took hold of the metal chassis, he received a severe shock. Please remember that a.c.-d.c. midgets usually have one side of the filament at 115 volts potential and make sure that the plug is out of the socket, or that gloves are worn when handling a "hot" a.c.-d.c. chassis. Especially is this true should the amateur be subject to heart ailment and,

at the same time, have wet shoes and be standing on a good "ground." A fatality might occur, which could easily have been avoided by taking precautions. Be careful—Death is so final!

\* \* \*

**A**N extremely clever and interesting gadget came to our eyes when we saw John F. Rider's new book, *The Meter at Work*. In it, Mr. Rider has divided the diagrams, physically, from the text. Each diagram is numbered separately as a figure. The construction of the book is such that the reader may refer to any diagram regardless of its position in the book at any time indicated in the text, which is on a separate page. We believe that Mr. Rider has made an unusual and welcome change in the ordinary text book. We know that his system will be widely followed in the future.

It seems that Mr. Rider's talents do not wholly lie in the field of signal tracing, where he was an outstanding pioneer, but also in the mechanical end of publishing. Which, of course, is his business.

\* \* \*

**A**ND that about winds up the column for another month. We are cheered by the fact that the Amateur Sub-Committee of the *Defense Communications Board* has requested that the Government not "blackout" the amateur radioman in a National Emergency. This, alone, has made the month well worth while. But read all about it yourself in the *Washington Column*. Incidentally the only gripe we can think of at the moment is that we are not so fortunate as to have a **W4 QTH . . . KAK**

-30-

**SAVE MONEY**  
 WITH THIS  
**Free Book**



**RADIOS**  
**PARTS**  
**P. A. EQPT.**  
**HAM EQPT.**

What a book to have! Just open it to the section you are interested in—there's your radio, sound system, your choice of nationally advertised parts. Everything in radio is here. But that's only the start of the story! Lafayette prices are the lowest—saving you money on everything you buy. Send for your FREE copy of this great buying guide today. Just tear out and mail the coupon.

**Lafayette Radio**  
 100 SIXTH AVENUE, NEW YORK, N. Y.  
 CHICAGO • ATLANTA • BOSTON  
 NEWARK • BRONX, N. Y. • JAMAICA, L. I.

**LA FAYETTE RADIO CORP.**  
 DEPT. 281,—100 SIXTH AVE., NEW YORK, N. Y.  
 Rush FREE Catalog No. 82

NAME.....  
 ADDRESS.....  
 CITY..... STATE.....

**English Servicemen**

(Continued from page 7)

alcove while extended remote controls were fitted so as to be handy at the bed-side.

A legal point in the order relating to car radios which was not fully appreciated at first by service engineers and radio dealers was that they were infringing the regulations every time they conveyed a portable receiver or any other type of self-contained battery receiver in their delivery vans. It did not matter whether the set was a new one being delivered or whether it was an old one being taken back to the shop for overhaul; the law as it stands just does not allow this to be done as the van immediately becomes a mobile receiving station which could be used by fifth columnists. The difficulty of conveying self-contained receivers may be overcome by ensuring that the batteries are not taken in the receiver or if they are, that they are packed separately and properly sealed. Only this week, a man was nominally fined as a warning because he took delivery in his own car of his portable receiver which had been repaired by his radio dealer. The judge made it clear that further offenses would be dealt with more rigorously.

**Spare Parts**

Obviously we must conserve our stocks of radio components and new production orders will be more difficult to fulfil as time goes on due to the needs of the fighting services for most of the materials used in their construction. All components that can be repaired are repaired, no matter how

high the labor cost may be, so long as most of the material in the components can be employed. In former days it was generally more economical to scrap the majority of small components rather than to attempt to repair them, but in present times every effort must be made to keep the components in circulation as long as possible.

It is not feasible rigidly to adhere to the letter of guarantees and manufacturers have to make concessions when they are not able to supply replacement components to the service man who has fitted a suitable component of other manufacture. Most manufacturers will give their dealers or agents credit for the amount they have expended in purchasing component parts for receivers still covered by guarantees and will not consider such actions as invalidating their guarantees.

Another case in point is where only one section of a multiple condenser bank breaks down. In normal times the whole bank would be replaced as a faulty component, taken out of the receiver and returned to the manufacturer for free replacement under guarantee. It is now permissible, however, to merely disconnect the faulty section of the condenser bank and then fit a single condenser of suitable characteristics mounted on the chassis in some convenient position.

Before the war, this would have been regarded as making the receiver non-standard and the manufacturer would not have had any dealings concerning that receiver on a no-charge basis. Today, action of this sort is appreciated and even encouraged.

#### Battery Economy

Battery receivers have been in many cases modified to take much less current than normal at the expense of a lowered audio output. The life of the battery is increased, thus conserving stocks while the reduced volume is a blessing in disguise as it automatically helps to solve the daytime noise nuisance for the many thousands of people who have to sleep in the daytime now that most of our factories are running night shifts. Old batteries are no longer thrown away at the end of their useful life but are collected and delivered to centers where they are broken up and most of their ingredients recovered for further manufacture.

#### Air Raids

The frequent air raids on London have created problems for the service engineer quite apart from the possible direct effect upon himself! More and more firms are working through air raid alert periods after the sirens have sounded and cease work only when danger is imminent. The civilian population, or rather the domestic side of it generally take cover in their shelters directly the sirens wail their wavering warning and it is thus a delicate question as to whether a service engineer arriving at a house during an alert warning should request the householder to leave the air raid shelter and let him carry out his work of repairing the receiver in the house. In the majority of cases, if no danger is apparent in the vicinity, people will allow the engineer to carry on, which he will do, making a dash for the family shelter should raiders appear overhead or the anti-aircraft gunfire become too fierce.

#### Air Raid Damage to Sets

An item which at first gave us quite

a thrill but which has now become commonplace, is the return to the service department for repair of radio receivers and radio-gramophones damaged in air raids. Some, of course, have been completely destroyed or are beyond repair after the houses in which they were used have suffered a direct hit by an H.E. bomb. Others which are only damaged are affected in various ways. Most of them require attention to their cabinet work due to flying plaster from walls or ceilings or from the white deposit which settles on everything after an incendiary bomb has been operating near by. This type of damage is quite distinct from any burning of the wood caused by a fire originated by the incendiary bomb.

Where sets have been in a position within the blast range of an H.E. bomb, it is often found that the cone of the loudspeaker is sucked outward toward the grill and is practically inside out.

Sometimes a receiver will sustain damage in transit during an air raid and pieces of shrapnel have been found inside the receiver after forcing their way through the carton and cabinet.

No doubt we shall have many more problems to face, but it is astonishing how quickly one can become adapted to a set of conditions which previously appeared to be intolerable. Before the war it was bad enough to contemplate the very idea of being bombed but to actually get used to it and discuss the previous day and night's visitations of the enemy as one used to discuss the latest sporting activities in the morning paper is a state of affairs which, although existent, is still difficult to believe.

It is, however, a fact, and if any more troubles come to the radio trade, we shall find ways of overcoming them and in any case they will provide me with a good excuse for writing another article!

-30-

### Frequency Standard

(Continued from page 22)

For operation four,—it really is a convenience. While not so distinct as the others, and probably not so requisite as they are, it is an advantage, and a distinct help in measuring the frequency of unknown signals. That feature is continuously variable output coupling. As can be seen, the tube acts in a shunt fed class "A" r.f. amplifier circuit with a conventional tuned plate tank. With the proper coils in place, it is possible to tune to any frequency as easily as tuning a regenerative receiver. But about the coupling—any tuned circuit has a fundamental frequency to which it presents maximum impedance to ground, and so delivering maximum output to the load at that frequency. If that circuit be detuned, it stands that less power would be delivered to the load, varying as the detuning effect becomes greater, until the point is reached where the circuit offers practically no impedance to ground, and all the signal is effectively grounded, and the output is killed.

It would be, we agree, probably less expensive, easier to operate, if a plug in an aperiodic tank were used in the plate circuit, but once this method of varying the output is tried, we believe that you'll agree that it can't be beat for smoothness of control. There is nothing of any conse-

## He Fought Your Battle!

"... It is ironic that among the hundreds of thousands of young radio engineers whose commonplaces of theory rest on what Professor Fessenden fought for bitterly and alone, only a handful realize that the battle ever happened."

—From an editorial in  
*The New York Herald Tribune*

Get the book that tells the true  
story of America's greatest Ra-  
dio Pioneer—

# FESSENDEN

## BUILDER of TOMORROWS

by

**Helen M. Fessenden**

As a radio engineer you owe it to yourself to know the human as well as the scientific side of the development of your industry—and of the life-long and triumphant fight that this man made to put across the ideas that make modern radio possible. Here for the first time is the whole story of Fessenden.

### THE MAN WHO:

Invented the wireless telephone.

Made the first radio broadcast in history.

First spanned the Atlantic with two-way radio.

Revolutionized navigation by the electric depth-finder for ships and the wireless compass.

Solved the problem of the U-Boat menace in the last war.

Blazed the trail in short-wave radio.

Here, for the first time, is the authentic story of America's greatest radio pioneer—Reginald A. Fessenden, one of the most interesting personalities in modern science. It shows the principles underlying his work and pictures the early trials of an industry that has become, largely through his amazing vision, the world-changing force it is today. An exciting biography, this book reveals frankly what happens to the independent inventor who pits himself against Big Business. Portrait frontispiece. Map end-papers, \$3.00

COWARD-McCANN, INC.  
2 West 45th Street, New York

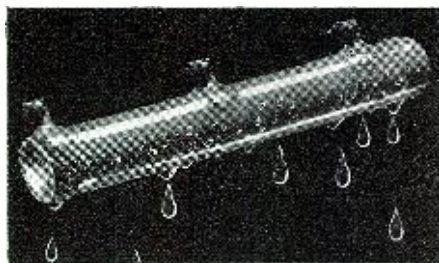

## WHEN A RESISTOR SWEATS!



Moisture, visible or invisible, will cause trouble if it can penetrate the protective surface of a resistor. A microscopic examination of the surface of a Vitrohm Resistor will show freedom from even minute enamel crazes or cracks. The resistance wire is sealed in Vitrohm, a glass-like enclosure, excluding moisture and assuring complete protection.

## WARD LEONARD ELECTRIC COMPANY

47 South Street Mount Vernon, N. Y.

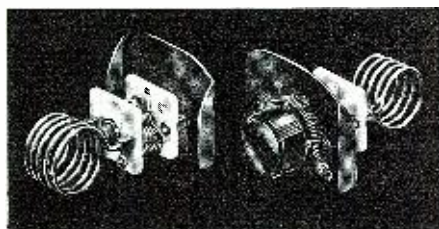

## MIDGET FREQUENCY METERS

MANY amateurs and experimenters do not realize that one of the most useful "tools" of the commercial transmitter designer is a series of very small absorption type frequency meters. These handy instruments can be poked into small shield compartments, coil cans, corners of chassis, etc., to check harmonics; parasitics; oscillator-doubler, etc.; tank tuning; and a host of other such applications. Quickly enables the design engineer to find out what is really "going on" in a circuit. Sold in sets of 4 in handy protective case or individually.

90605	Range 2.8 to 9.7 mc.	\$1.65
90606	Range 9.0 to 28 mc.	1.65
90607	Range 26 to 65 mc.	1.65
90608	Range 50 to 140 mc.	1.65
90600	Complete set of four, in case.....	6.50

JAMES MILLEN MFG. CO. Inc.  
150 EXCHANGE ST. MALDEN, MASS.

quence to wear except the bearings on the variable condenser, and they're good for the life of the instrument.

Looking at the front panel,—the two large dials are for setting the frequency. On the left is the dial to the large two-gang crystal condenser, and on the right is the variable resistor that sets the division frequency of the multivibrator. Then there are the two small dials just under the larger ones. The one on the left is a "dud"—practically speaking. It merely controls the ON-OFF switch for the whole unit, and is in the a.c. line. On the right is the condenser for the 6L7 output amplifier tank, and is used to control the output injection and frequency.

There are also four switches under the meter. When once the unit is set and calibrated, it is a small inconvenience, before each measurement is made, to flip each switch in turn and read the various currents. After making the first readings, it can be seen by comparison whether any stage is very far out, or if they are all working properly. It (the meter) is tied into the plate of the 6L7, in both plates of the 6N7 multivibrator, and in the plate of the 6J7. Of course, any place where it will read the current drawn by each unit is okay, since it is for comparison only.

The switch on the lower left is connected in the cathode of the 6L7, and when it breaks the circuit it throws the entire 25,000 ohm resistor in the circuit, biasing the tube to cut-off and killing the output since the output of the 6J7 is not enough to drive the grid up to where the plate would draw current.

The other toggle—to the right of the output switch, is connected across the grid of the second section of the multivibrator. When closed, it shorts out and stops the multivibrator output. And that's another place where the output tube comes in. With this layout, it is possible to kill the multivibrator output and not affect the crystal oscillator loading or calibration in any way. Thus, there is absolutely no crystal shift when going from the 10 kc. multivibrator to straight 100 kc. oscillator.

That just about covers all the circuit design and constructional features, but read on. That's not all.

### Construction

We aren't going to try to tell you how to build your replica of this instrument—everyone has his own ideas about that. But anyway, here's the main idea of how ours was put together.

Our unit is built up on a *Par-Metal* chassis 17 by 8 by 3 and the cabinet, also *Par-Metal* is standard size with relay-rack type front panel. Cabinet size: 13"x8 3/4"x19".

It should go without saying that all parts should be mounted so as to get rid of as much vibration as possible. All wiring is done with No. 14 tinned bus; and if the length of the connection is over three inches, is supported at its mid-point by small insulators fastened to the chassis. Where wiring must handle r.f., and must pass another point carrying another r.f. potential, wiring is done with shielded wire. This type of wiring may be seen on the division control resistor to the right of the meter.

All r.f. points on top of the chassis are shielded. Small caps are placed

over the grid caps of the tubes, and the 6L7 tank coil is mounted inside a shield can. All grid leads are of shielded wire and are tied to the chassis every inch or so.

By looking at the rear view of the unit, the output cable may be clearly seen. This cable is made up on single conductor mike cable connected as a concentric line. In using this type of connection for the output we obtain a match to almost any type of receiver. Two insulated alligator test prods are used as the output terminals and may be clipped on to whatever points are available.

Our line up is as follows—this doesn't mean that you'll have to use it. Looking at the back view, on the extreme right is the power supply—80 tube, transformer, choke and *Solar* condenser. The two gang condenser is part of the series crystal tuning circuit, and the coil shield in the center of the chassis houses the crystal, its series inductance, and lots of felt and rock wool. We recommend that this one feature be retained if nothing else is. By using alternate layers of felt and rock wool the temperature change inside the shield may be lowered to the point where it may be considered to be nil.

The three tubes in order, right to left, are the 6J7 oscillator, 6N7 multivibrator, and the 6L7 output harmonic amplifier. Right behind the 6L7 is the output tank, and this must be shielded too. The potentiometer behind the shield is the variable division control in the first 6N7 grid. Hidden behind the crystal shield are the four toggles that insert the meter in different spots in the circuit.

By looking at the front panel the unit may be seen as it is actually in use. The receiver is a *Hallcrafters* SX-17 and the output is hooked directly across the doublet input terminals. If the coils are wound according to specifications with the four turn pick-up coil wound with an *open* end as indicated on the diagram, there will be no detuning effect whatsoever on any frequency.

This ought to be just about enough on construction. You won't build it like ours anyway, but these have been just a few hints.

### Calibration and Alignment Operation

As we stated a while ago, it takes a thorough understanding of the theory back of a multivibrator to obtain maximum results. However, the actual setting up and operating procedure are not nearly so complicated as might be thought.

First in order is to set the crystal. With a receiver (any receiver accurate to just 100 kc. is enough) tuned to WWV on 5,000 kc. connect the multivibrator output to the antenna and ground posts. There should be absolutely no pulling, because the only connection made to the frequency standard unit is through the open-ended four turn pickup coil, and that practically may be considered an open circuit. As you remember, as under "construction," the coupling "concentric line" is nothing more than single conductor microphone cable, and it goes without saying that the shield goes to the receiver's ground post.

Next, turn on the multivibrator unit and kill the 10 kc. output with the switch supplied for this purpose. This

leaves only the 100 kc. bar in the circuit. Now, the tank to the 6L7 stage is varied over its entire range until some sort of a beat note is heard—don't worry, you'll hear it. Now, with the crystal tuning condenser, set the oscillator to zero beat with the signal in the receiver. This is not as easy as it sounds, but it can be done. Anyway—one cycle off at 5,000 kc., the 50th harmonic of the 100 kc. oscillator is but 1/50th cycle off at the crystal fundamental so don't worry.

Now, turn on the receiver and find two points on the dial where the 100 kc. output of the crystal can be heard. It should be noted here that calibration will be easier to effect if some little used portion of the spectrum is used, not that the frequency matters. This above should be done with the bandsread dial so that tuning will be easier.

This part is fun—heh! heh! Now, with the crystal running, and the receiver set on one of the calibration points just found, switch on the multivibrator section. Start tuning, with the receiver of course, from one point to the other, counting beats as you go. There may not be any, and there may be so many you can't count them. Anyway, it goes something like this. If there are 13 intermediate points between the two that are known to be 100 kc. apart, then the unit is dividing by 13 plus 1—the last point counts too—or 14 divided into 100, or about every seven kc. Now, look at the diagram. There are two silver mica condensers connected across the trimmers that took so much trouble to mount. These are the coupling condensers, and the trimmers are there for just this purpose—i.e.—to get the blank thing where it belongs and make it operate right. By varying these trimmers one way or the other it becomes possible to obtain nine points between the two 100 kc. points, thus making the multivibrator divide *exactly* by 10, or beat every kc. These adjustments should be made with the variable grid resistor set at about half scale so that by varying it the multivibrator will divide by 9, 10, or 11—thus getting readings at approximately 11 kc.—exactly 10 kc., and about 9 kc. By simple mathematics it becomes a simple matter to ascertain whether a signal is higher or lower in frequency by the changing of the beat note as the division frequency is shifted.

When all these conditions are fulfilled you can measure to your hearts content. There are all sorts of ways of working through to a conclusion with a multivibrator, but here's the general idea.

First—zero beat the 100 kc. crystal with WWV by tuning in the 5,000 kc. signal on the receiver and varying the multivibrator amplifier tank until a beat note is heard in the receiver. Then tune for zero beat with the crystal tuning condenser. Then tune in the signal to be measured with the receiver and note the dial setting. By knowledge of the calibration you can determine whether the signal is on, for example, 7,300 or 7,400 kc., or which point it is closer to. Again, just for convenience, let us say that we have found the signal to be in between the two points just named, i.e., 7,300 and 7,400 kc. Therefore it

is going to be some frequency higher than 7,300 and lower than 7,400 kc. All this can be found without the aid of the multivibrator.

Now turn on the 100 kc. oscillator, but with the division unit *off*. After noting the signal's position on the dial turn back to the lower end of the dial until the first 100 kc. beat is heard. This will be 7,300 kc. Turn on the multivibrator and set it to divide by 10, thus getting beats every 10 kc., and with the receiver dial, start up toward the signal frequency—counting the beats as they are passed. Every beat passed marks 10 kc. higher in frequency than the 7,300 kc. base and is added to it. If the signal appears between the 6th and 7th beat, the signal frequency lies somewhere between 7,360 and 7,370 kc., and by obtaining a ratio from the bandsread dial on the receiver estimates may easily be made that can be assumed to be accurate to within 500 *cycles*. In percent, on the higher frequencies, this is within government rulings, but for exact measurements some other method must be used. However, it goes without saying that if the signal is supposedly some even multiple of 10 kc., and is within a very few cycles of its frequency, the cycles may be *counted* as the beat note will be so low as to come at intervals so separated as to make a pulsing beat at regular intervals dependent upon the deviation.

To obtain exact measurements on odd frequencies, the procedure may vary. Naturally there will be a beat note in the output of the receiver that represents the difference between the signal frequency and the nearest 10 kc. beat point. This is fed into some sort of a mixer and the output of an audio oscillator fed into the same mixer and then the output run into some sort of a null indicator, with provisions made for varying the audio oscillator's frequency. By varying the oscillator a point will be reached where the two beats will cancel, and then the beat frequency may be read directly off the audio oscillator's dial. For instance—say our signal made a 3,130 cycle beat with 7,360 kc.—then the resulting frequency would be 7,360 kc. plus 3.13 kc., or 7,363.13 kc.—which is pretty accurate.

That's all there is to it. If you're going to measure broadcast frequencies they'll all be multiples of 10 kc. and you can measure to tenths of cycles by counting beats, or, if you're measuring odd high frequencies, you can read to tenths of kilocycles—either case satisfying all precision and FCC regulations.

So—maybe you won't have all the headaches we had—maybe you will. At any rate you'll be able to split a hair when it comes time for a frequency check, and that's close enough. Besides measuring frequencies, this standard will provide 10 kc. output that is accurate enough for setting wavemeters, heterodyne frequency meters and all such equipment to well within regulations, and for all ordinary purposes, with a little discretion and practice, may be considered exact.

We hope you like it—if you don't get it to work the first time, don't feel too badly about it. We didn't either.



# "Here's the Big Book of RADIO VALUES"

**FREE**  
GET IT NOW!  
212 PAGES!  
EVERYTHING IN RADIO!



## 85 NEW Knight RADIOS

See them all—1941's Radio Hits! Models for every purpose—at every price. Plastic and wood panel models, world-wide sets, Personal and 3-way Portables, Auto Sets, and Piano Radio Combinations, Auto Sets, and Piano Radios, Amateur Receivers—all at new low prices! See them in this greatest of Radio Catalog!



## Save money on EVERYTHING IN RADIO

24 New Sound Systems, complete P.A. listings, 11 new Amateur receivers and complete Ham gear selections, books—more than 15,000 and Everything in Radio at Lowest Prices in your ALLIED Catalog!



## RADIO BUILDERS!

**BUILD YOUR OWN!** Count on ALLIED for the latest low-cost kits and for help in building any type of radio. ALLIED is Headquarters for Radio Builders!

The "Radio Builders Handbook" — valuable beginners' book on radio, easy to understand, illustrated. Only 10c.

New! "Radio Dictionary," Compiled by experts, under ALLIED supervision. Gives concise, easy-to-understand definitions of all commonly used radio terms and words. Only 10c.

**DON'T MISS THE BARGAIN SECTION**

# ALLIED RADIO

833 W. Jackson Blvd., Dept. 1-B-1 Chicago, Illinois

- Send me your FREE 1941 Radio Catalog
- I enclose 10c for New Radio Dictionary.
- I enclose 10c for Radio Builders' Handbook.

**FREE CATALOG**

Name .....

Address .....

City..... State.....

**Use these BUD Metal Cabinets . .**



**. . . to protect your equipment**

Whether you're building a pocket receiver or a kilowatt transmitter, there's a BUD Cabinet exactly suited to your application.



See your jobber, or refer to No. 141 BUD Catalog for complete listing.

**BUD RADIO, INC.**  
CLEVELAND, OHIO



**FULLY A-U-T-O-M-A-T-I-C**

★ Remember how you were going to dress up and snap up that rig? Well, the opportunity still holds good . . . and with only 10 out of 49 zones still open, there's no alibi for not making your rig the best in the district. Besides, you need an excuse for staying up these nites.

**Low-Priced RELAYS by Guardian**  
Can help your dream of a new, fully automatic rig come true.

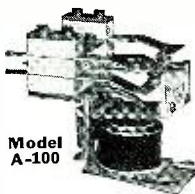

Model A-100

Standard A-100 and A-100-C Antenna Relays AISimag insulated operate on 110 V. 60 cycle A.C.

Amateur List Prices:  
A-100 Double Pole Double Throw Relay . . . \$5.95

A-100-C Single Pole Double Throw Relay . . . \$3.30

R-100-G Triple X insulated . . . \$5.00

Write for New Bulletin "N" and Free Circuit Diagrams. Order Today!



**GUARDIAN ELECTRIC**

1630 W. WALNUT ST. CHICAGO, ILL.

**Civilian Radiomen**

(Continued from page 8)

ments, or in tests of complete radio equipment to demonstrate compliance with specifications, for 1 year of the specified experience. Each year of experience in supervising the assembly, disassembly, overhaul, repair, etc., of modern radio communication equipment, for 1 year of the specified experience, up to 2 years.

**Qualifications—Junior Inspector**

Two years of experience of the type described above.

Each year of an engineering course in a college or university of recognized standing may be substituted for 6 months of the specified experience.

The maximum age limit for Senior Inspector and Inspector is 62. For Junior Inspector it is 35.

**INSPECTOR, SIGNAL CORPS EQUIPMENT (No. 108)**

**Salary**

Senior Inspector—\$3,200.  
Inspector —\$2,600.  
Junior Inspector—\$2,000.

For employment in the Signal Corps, War Department.

**Duties**

To make inspections and tests of varied signal corps equipment, radio, telephone, telegraph, and power units, assemblies, subassemblies, and components to determine compliance with specifications; to make inspection reports; to conduct correspondence; and to perform related duties as required.

**Qualifications—Senior Inspector and Inspector**

Four years of study leading to a bachelor's degree in electrical or radio engineering in a college or university of recognized standing. Also, for Senior Inspector, 3 years, and for Inspector, 2 years, of experience in the inspection and/or testing of radio equipment, components, parts, assemblies, etc., to determine compliance with specifications. This may be on aircraft or non-aircraft equipment, or both.

**Qualifications—Junior Inspector**

The educational requirement is the same as for Senior Inspector and Inspector. There is no experience requirement.

**Substitutions—All Grades**

Additional inspectional experience, of the type described above, may be substituted, year for year, in lieu of the specified education. For each year of inspectional experience, applicants may substitute 1 year of engineering experience in the field of communication and/or navigational radio work may be substituted, *provided*, that applicants for the senior grade must show at least 1 year of inspectional experience.

**RADIO MONITORING OFFICER (No. 91)**

**Salary**

Radio Monitoring Officer—\$3,200 a year.  
Assistant Radio Monitoring Officer—\$2,600 a year.

For employment in the Federal Communications Commission.

**Duties—Radio Monitoring Officer**

To be in charge of a secondary monitoring and direction-finding station, with responsibility for the proper performance of all activities of Assistant Monitoring Officers and of Radio Operators assigned to the station; to be

responsible for the calibration and maintenance of equipment, the assignment and supervision of personnel and coordination of activities with the activities of other government departments; to prepare reports, and to perform such other duties as may be assigned.

**Duties—Assistant Radio Monitoring Officer**

To stand watch on communications channels for the purpose of making frequency measurements, of copying telegraphic communications, and of recording transmission.

Employees in both grades are required to drive inspection cars and mobile laboratories. They may be transferred from one district to another as the occasion demands.

**Qualifications—Radio Monitoring Officer**

Seven years of experience in a technical capacity in connection with installation and testing, inspection and testing, or operation with maintenance responsibility, of radio transmitters of at least 100-watt output. This must include at least 2 years of supervisory experience.

**Assistant Monitoring Officer**

Five years of experience of the type described above. No supervisory experience is required.

For both grades, applicants must hold valid first-class radio telegraph operator's licenses, or within 6 months after appointment must demonstrate their ability to send and receive at 25 words per minute.

Special credit will be given for experience in using radio direction-finding equipment and in making field-strength surveys.

**Substitutions**

Up to a maximum of 4 years, technical experience in radio engineering, or courses in electrical or communications engineering at a college or university of recognized standing, may be substituted, year for year, in lieu of the experience specified above.

**RADIO ENGINEER (No. 83)**

**Salary**

Senior Engineer—\$4,600 a year.  
Engineer—\$3,800 a year.  
Associate Engineer—\$3,200 a year.  
Assistant Engineer—\$2,600 a year.

For employment in any of the Government agencies employing radio engineers.

**Duties**

To perform, or supervise the performance of, professional engineering work in design, construction, testing, research, investigation, or production in radio engineering. The difficulty of the work performed, the degree of supervision to which the employee is subject or which he exercises, and the responsibility assumed, will vary with the grade of the position.

**Qualifications**

Education—(1) Completion of a full 4-year course leading to a bachelor's degree in engineering in a college or university of recognized standing, or (2) 2 years of such education plus 2 years of professional engineering experience, which experience must be in addition to that prescribed under "Experience", below.

Experience—Experience in radio engineering, as follows: Senior Engineer, 6 years; Engineer, 5 years; Associate Engineer, 3 years; Assistant Engineer, 2 years.

All the jobs which we have mentioned here are being filled, and will

continue to be filled, in accordance with civil-service law. This means that appointments will be made solely on the basis of merit and fitness, as shown in the statements of the applicants and as shown by corroborative evidence gathered by the United States Civil Service Commission. While all jobs in the Federal Government are not subject to civil-service law—or, as it is sometimes expressed, all are not "under civil service"—most of them are.

#### Civil Service Offices

The necessary forms and announcements for all these jobs can be obtained from the *Secretary, Board of United States Civil Service Examiners*, at any first- or second-class post office, from the *United States Civil Service Commission, Washington, D. C.*, or from the *United States Civil Service District Office* at any of the addresses given below. (In writing, you should specify the title of the position in which you are interested.)

Notices regarding jobs are posted in all first- and second-class post offices.

#### Basic Requirements

All jobs under civil service have certain basic requirements. For instance, the applicant must be a citizen of the United States. Before the applicant is appointed, his fingerprints will be taken. Fingerprints are used in determining whether applicants have arrest records.

In some examinations, competitors who receive a tentative eligible rating are investigated with the object of securing additional information as to their qualifications, fitness, honesty, integrity, habits, and general character. The investigation may include an oral interview which, if given, will be held at points as convenient for applicants as conditions will permit. Travelling expenses, if any, of applicants must be borne by them. Any such investigation of eligibles is made in the order of their standing on the eligible list, and only if there is a reasonable chance of their receiving appointment.

Lack of physical vigor, inability to cooperate with others, intemperance, or other characteristics which in the judgment of the Commission would render the applicant unfit or undesirable for the position, will be considered sufficient ground for his rejection. Also, convincing evidence of facts in the applicant's past history involving moral turpitude (a broad term including any form of depravity, etc.), disrespect for law, or unethical dealings, will be considered sufficient ground for his rejection.

#### Physical Condition

Applicants must be in good physical health. Hernia (with or without truss), organic heart disease, or other serious physical defects will disqualify for appointment. These or other remediable defects, or curable diseases, will not exclude a person from examination but the disease must be cured, or the defect remedied, before appointment is possible.

Height and weight requirements, and other physical requirements, vary in accordance with the nature of the position. Each examination announcement sets forth the physical requirements which have been established for the particular position for which the examination is to be held.

A rigid physical examination is made by a Federal medical officer before appointment. Persons who are

offered appointments must pay their own expenses in reporting for duty. If, upon reporting at the place of assignment, they are found ineligible because of physical defects, they cannot be appointed and no part of their expenses for returning home can be borne by the Government. Thus, if you have any doubt as to your physical condition, you should give careful attention to the physical requirements as set forth in the announcement. If you find you cannot meet the requirements, you should not apply.

#### Age Limits

For some of the positions mentioned the maximum age is 55; for others, it is 62. Age limits do not apply to persons granted veteran preference, except that the applicant must not have reached retirement age. Proof of date of birth must be furnished upon appointment. A birth certificate or photostatic copy is the proof most commonly submitted.

#### Education

For most positions in the Federal civil service, there are no educational requirements. The mechanical and trades positions are in this category. Applicants for these positions are rated on the quality and extent of their experience. For other positions, high-school education is required, and sometimes certain college education, or college graduation, is required. In many cases, experience beyond the minimum period specified can be substituted for part of the educational requirement. Similarly, additional education can often be substituted for part of the experience requirement. Where such substitutions are permissible, the examination announcement so states, and the extent to which they may be made is explained.

In filling out the application, answer the questions fully. This is the only way the Civil Service Commission can correctly ascertain your true qualifications. But do not "brag." Do not falsify. Exaggeration and falsification are easily detected and may disqualify you.

The information in this article regarding examination requirements has been obtained from the printed examination announcements issued by the United States Civil Service Commission. It has been necessary to present much of this information in abbreviated form. Anyone wishing more detailed information may obtain it from the Commission's Washington office, from one of the district offices, or from the Commission's local representative at any first- or second-class post office.

#### U. S. CIVIL SERVICE OFFICES

- Atlanta, Ga., New Post Office Building.
- Boston, Mass., Post Office and Courthouse Building.
- Chicago, Ill., New Post Office Building.
- Cincinnati, Ohio, U. S. Post Office and Courthouse.
- Denver, Colo., Post Office Building.
- New Orleans, La., Customhouse.
- New York, N. Y., Federal Building, Christopher Street.
- Philadelphia, Pa., Customhouse, Second and Chestnut Streets.
- Seattle, Wash., Federal Office Building.
- St. Louis, Mo., New Federal Building.
- St. Paul, Minn., U. S. Post Office and Customhouse.
- San Francisco, Calif., Federal Office Building.
- Honolulu, T. H., Federal Building.

## Presenting the 1941

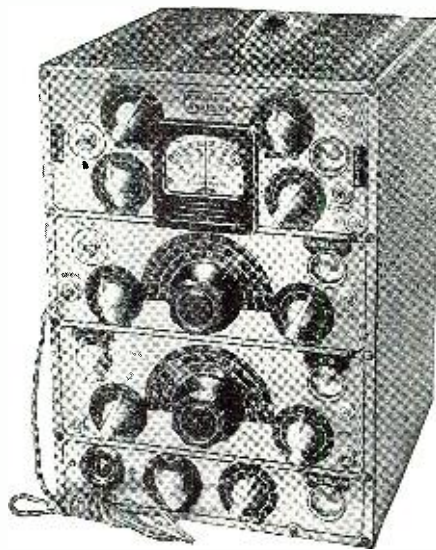

### Meissner ANALYST

Incorporating a New, Direct-Reading  
ELECTRONIC VOLTMETER

Save Time—Save Money—Handle service jobs faster with the assurance that they will "stay sold"! Almost Magical in its uncanny ability to ferret out obscure faults and lay them open for your inspection, the New Meissner ANALYST handles the receivers of yesterday, today and tomorrow—with equal efficiency and facility. Entirely fundamental in its testing procedure, it is one piece of equipment that will never become obsolete!

The New Meissner ANALYST locates faults by the "Signal Tracing" method—proven to be the fastest and most reliable. Five separate and distinct "channels" provide as many different functions, each in its own panel division with all controls accurately calibrated. Furnished with tubes and instructions, complete—ready to go to work!

No. 9-1040 New ANALYST **\$87.50**  
Complete with Tubes, Net . . .

Limited Quantity of 1940 Models  
Available at Reduced Price!

The same ANALYST that sold *in kit form* at \$100 list—now offered completely wired, with full set of 13 tubes—ready to operate! Similar to the New ANALYST described above except has electron-ray indicator instead of meter for DC measurements.

No. 9-1025 Net Price . . . \$69.50

Write for Free 1941 General Catalog

Dept. N-2



# BE PREPARED

FOR THE

## NAVY, ARMY OR COMMERCIAL FIELD

For over a quarter of a century the Candler System has trained men at home with their simple, practical system. You, too, can learn code the Candler way, easily and quickly. Let Candler give you that "co-ordinative Knack" necessary to speed, skill and copying behind.

The Communications Reserve of the U. S. Navy is enlisting 5400 expert radio operators. You can qualify in half the usual time for your amateur or commercial license and a good rating by taking Candler Training NOW!

Write today for the New Book of Facts. It's FREE! It tells you how Candler trained world-famous speed champions. Get Candler's inside tips—drop a postcard now to

### CANDLER SYSTEM CO.

DEPT. Q-1  
ASHEVILLE, N. C., U. S. A.



**NEW! 1941 MODEL Pocket Tubes Batteries Radio Plug in**

**DURABLE PLASTIC CABINETS**  
Dual Bands—Magictenna—Microdial

Fits your pocket or purse. Wt. 6 ozs. Small as cigarette package. Receiving standard & short wave. **PATENTED POWER RECTIFIER.** No tubes, batteries. Hi-tone easy tuning slide "MICRODIAL." M. OF H. SAYS: "MIDGET RADIO WORKS FINE!" **ONE YEAR SERVICE GUARANTEE!**

Sent complete ready to listen with instructions & tiny phone for use in homes, offices, hotels, in bed, etc. **SIMPLE TO OPERATE—NO ELECTRICITY NEEDED.** **SEND NO MONEY!** Pay postman only \$2.99 plus postage charges on arrival or send \$2.99 (Check, M.O., Cash) and Yours will be sent postpaid. A MOST UNUSUAL VALUE! ORDER NOW! **FREE! PLUG IN "MAGICTENNA"—ELIMINATES OUTSIDE WIRES! MIDGET RADIO CO., Dept. HG-2, Kearney, Nebr.**

**Amazing New "WALSCO" STAPLE DRIVER**

for radio men, electricians, or anyone doing stapling. Makes wire and cable installations twice as easy—much faster—over half the time. Wires can be stapled in corners, behind pipes, into moldings—places never accessible with a hammer and ordinary staples. Drives staples even into walls, brick, mortar, etc. Magazine works automatically and holds strips of staples which come in several colors. Ask your jobber for demonstration and catalogue 41-C of all WALSCO PRODUCTS

or write **WALTER L. SCHOTT CO.**  
5264 W. Pico Boulevard, Los Angeles, California

**GOLDENTONE... 50% OFF**

DEAL DIRECT... FACTORY PRICES...  
Over 60 models to choose from  
— 4 to 12 tubes. Portable  
\$8.95 up. Farm sets \$8.95 up.  
Car sets \$8.95 up. Portable  
hand sets \$8.95 up. Samples  
50% off. Quantity dis-  
counts. Free 1941 Barzain  
catalog—eigen details of 10-  
day FREE trial, agent's propo-  
sition and discounts. No  
obligation. Mail postpaid to  
**GOLDENTONE RADIO CO.**  
Dept. R. N. DEARBORN, MICH.

Free Catalog of RCA LICENSES

**SOLAR RED-CAPS**  
Smaller Diameter Dry Electrolytics

**SPEED Servicing**

Write for Catalog

**SOLAR MFG. CORP.** Bayonne, New Jersey

**LES LINCOLN ENGINEERING**  
Correspondence Course...  
**RADIO and ELECTRICAL ENGINEERING**

**ELECTRICAL ENGINEERING** Get good grasp of wide electrical field. Prepare yourself at Low Cost, for secure future. Modern course. So simplified anyone can understand quickly.

**RADIO ENGINEERING** Extra fine course in radio, public address, photo-electric work. Training you to be super-service man, real vacuum-tube technician. Experimental kits furnished. Diploma on completion.

Either course, only \$25. Deferred payment plan available. Write for free copies of school catalogue, student magazines, full details. **SEND NOW!**

**LOWAS \$25**

**LINCOLN ENGINEERING SCHOOL, Box 931-R 26, LINCOLN, Nebr.**

You will find full coverage in RADIO NEWS. 25c at your newsstand.

### Calibrated ECO Transmitter

(Continued from page 18)

temperature, and their use is practically compulsory.

The grid leak shunt condenser, which is a .00025 mfd. should also be of the silver-mica type.

A great part of the stability in the oscillator circuit will depend upon how the grid tuning components and parts are wired and mounted. Wiring should be done with solid copper wire of at least No. 14 size.

The plate tank of the oscillator tunes to a frequency higher than that of the grid, usually the second harmonic. This coil is of the plug-in type and is located above the tank condenser as seen on the chassis. It may appear that a rather large condenser has been used for tuning of this circuit. We decided to use this to balance the assembly as well as to provide a minimum of loss and to keep the minimum tuning capacity to a low value. A metal baffle is constructed to isolate the grid circuit from the plate circuit. This shield is highly important and may not be eliminated under any circumstances.

Voltage regulation becomes an important problem in E.C.O. operation. The screen of the oscillator should be kept at a constant voltage over the entire frequency range so that the characteristics of the circuit will be unaffected by changes of temperature or current flowing within the tube. A VR105-30 RCA voltage regulator tube is used to stabilize this screen voltage at a potential of 105 volts which is maintained over a wide current range. Inasmuch as the plate current is largely dependent on the screen voltage, the inclusion of this regulator will tend to keep the plate input constant. A Triplet 0-75 d.c. ma. is included in the plate circuit to indicate operation of the plate and to indicate proper tuning resonance.

The next tube in the line-up is a 6V6G doubler. Due to the fact that this tube must drive a push-pull stage, it was necessary to add in a neutralizing condenser, as indicated, although, of course, it is not actually required from an electronic standpoint. A center tap is used on the coil, L3, and this coil is tuned by a two-gang Hammarlund HFBD-100C condenser. A combination of cathode and grid-leak bias is used, the former being required to safeguard the tube from plate-current surge when the oscillator tank is detuned, or out of resonance.

Were it not for the addition of cathode bias, the plate current would rise to a value far in excess of the normal plate current rating. This tube and coil is located in back of the baffle shield directly opposite the VR105 and the 89 tubes.

The amplifier stage is designed around the new RCA 815 dual beam power amplifier. The signal is fed to the grids through the coupling condensers C13 and C14, while a center tap is provided by connecting two r.f. chokes in shunt across the grids and by using the mid-point for the grid return through R5, the 0-10 d.c. ma. to ground. A combination of grid-leak and cathode bias is also used in this stage. The resistor R6 must be heavy enough to dissipate the full wattage of the tube. A very high order of effi-

ciency was obtained in the design of this stage due to the use of the RCA 815 and to the tuning condenser used. Both of the plate connections are made to caps on the glass envelope of the tube. By mounting the coils L4 above the chassis and along the side of this tube, short leads may be used, both to the coil and to the tank condenser which is mounted directly beneath the coil.

A 0-250 d.c. ma. is wired in permanently and this reads the combined plate and screen currents of the two sections of the 815 tube. All final amplifier coils are available commercially. These are Bud, RCL coils furnished with a center link. The output of these coils may terminate to any conventional low impedance line.

No provision has been made for coupling to antennae which require tuned feeders as we felt that a separate antenna coupler would be desirable in order to eliminate component parts which might not be used.

#### Power Supply

Parts used in the power supply were chosen for continuous operation. There is a distinct advantage of using a separate filament transformer and a separate plate transformer. In order to keep a constant temperature in the cabinet during stand-by periods we decided that the filaments should remain lit. The life of a vacuum tube is actually increased rather than decreased when its filament is permitted to be in normal operation during its life. The closing of SW1 turns on the filaments for all of the tubes in both the transmitter and the receiver, as well as the 5 volt supply for the rectifiers. The other switch, SW2, controls the plate supply.

A common voltage divider is used for the proper setting of the various potentials used throughout the assembly. This resistor, designated as R8, should be mounted as indicated where it will be away from any condensers which could be harmed by any heat which might be given off by this resistor.

Choke input is used in order to stabilize the voltage. Condenser C23 has been made large in capacity so that if the constructor wishes to add on a modulator unit there will be a very low hum content to cope with. A terminal strip is provided for the insertion of a line from the modulation transformer for this application. This assembly should be insulated adequately and should not be exposed. Remember that even a potential of 500 volts d.c. can be highly dangerous and is to be avoided. *Play safe by using an assembly which is provided with insulated terminals!*

#### Tuning and Operation

If the operator will exercise intelligent procedure in tuning the transmitter, he will be assured of results which will not only be highly satisfactory, but which will afford a high degree of flexibility in operation. The complete r.f. section should be tuned in conventional manner for the initial adjustment. After all of the various potentials are set to their proper value, and when the tubes are operating normally, as indicated, by observation of the meters, he may proceed with the calibration of the E.C.O. unit.

The 89 oscillator grid coil is wired into the circuit permanently. After this coil has been wired in place, it should not be altered in any way as



this would upset the original calibration.

A small loop of wire placed somewhere near the L2 coil is connected to the primary of the receiver coil, L5. This coupling must be extremely loose so that the signal from the E.C.O. will not blanket that being received from some B.C. station, which is being used as a frequency standard.

A broadcast station of *known frequency* is first tuned in on the receiver, making sure that the tuning eye shows that the set is tuned to maximum resonance. The E.C.O. is switched on, and the condenser, C1, which is under the chassis, is set to half capacity. Next, the main E.C.O. dial is rotated until the signal of the B.C. station beats with the frequency in the grid circuit. This will be  $\frac{1}{2}$  the frequency of the L2-C5 combination. After a suitable beat note is heard in the phone, the main dial should be calibrated at that point.

Now, without touching this main dial, tune the bottom condenser until zero beat is heard in the phones. The main dial is now calibrated to a harmonic of the particular broadcast station used for the standard. By plotting various points through the range of the L1 coil, the operator may always return to that station by going through the above procedure and by so doing will obtain a very high order of accuracy.

Note that the top condenser, C1A, is simply a vernier in parallel with the main tuning condenser. From this we see that we actually have a band-spread arrangement which enhances the value of being able to identify the points of calibration.

Once the entire spectrum has been calibrated on the main dial, it will only be necessary that the operator set the dial to some *known frequency* and then to tune in the B.C. signal on the receiver and to readjust the vernier condenser, C1A, to the zero beat position. In other words, the operator can always return to the station for a frequency check, and the vernier condenser will allow for any change in the characteristics of the E.C.O. which might be caused by changes in room temperature and in line voltage variation.

### For Immediate Release

(Continued from page 37)

stead of the usual 30 frames necessary for rapid-decay screens, the flicker is not discernible when using the white-delay tube. Whirling disc tests for trailing indicate no objectionable degree of motion blur over a wide range of speeds, while in the handling of film subjects the carry-over feature definitely contributes to smoother action. Comparative tests of pictorial contrasts between the white-delay screen and standard screen have shown the former to be quite satisfactory. Meanwhile, comparative tests of resolution or pictorial detail between 625-line scanning made feasible by the white-delay tube, and the usual 441-line scanning, indicate a marked gain. With the usual rapid-decay tube, half the lines are lost by the eye in following motion, whereas the eye sees this additional detail with the delay tube. Also, the delay tube eliminates interline flicker at 30 frames.

*Du Mont* engineers have also been demonstrating the *Du Mont* synchronous system utilizing driven receivers which follow line and frame changes automatically and require no oscillator adjustment, thereby eliminating the obsolescence angle which has handicapped television commercialization.

-30-

## RADIO PHYSICS COURSE

by Alfred A. Ghirardi

(1) A modern receiving set must separate the signals of any station it is desired to hear, from those of all other stations. The *selectivity* of a receiver is a measure of this ability to discriminate between the wanted and unwanted signals. Of course we would like to have a receiver which will respond only to one given station at a time, and not at all to any other, no matter how powerful the undesired signal is, or how close in frequency it is to the desired signal. This perfect selectivity is very difficult, if not impossible to attain in practice, but we now have receivers which are as selective as we really need them under present broadcasting conditions.

(2) The receiving equipment must also amplify the incoming signal voltage of the desired station until sufficient energy is available to operate the loud speaker as loudly as desired. The *sensitivity* of a receiver is a measure of the overall amplification from the antenna-ground terminals of the receiver to the loud speaker. Needless to say, it is desirable to have the sensitivity as high as possible, for then it requires but a small input signal voltage to deliver considerable output power to the speaker. It is also true, however, that a sensitive receiver without adequate selectivity is useless, for the more sensitive it is, the more stations it tends to bring in at once with loud speaker volume and therefore the greater is the need for eliminating the signals of these unwanted stations.

There is another very definite limitation to the amount of sensitivity required. The combination of all noises coming into a radio receiver is usually taken to be the *noise level*. These noises are caused by true static, electrical interference, by re-radiating receivers, or by any apparatus or device which produces electrical impulses which may be picked up by the receiver. The limit of radio reception is governed by the distance and power of the transmitter and also by the stray electrical disturbances which drown out the signals as soon as the intensity of the latter falls to a certain degree. A point is reached where the signal from the station has less strength than these stray impulses forming the *noise level*. It is then impossible to receive the station without this interference, because the receiver will amplify the noise voltages equally as well as it amplifies the true signal voltages, since they are of the same electrical nature.

(3) A receiver must also reproduce in the form of sound waves, the exact wave-form of the sound set up in the broadcasting studio. The *fidelity* of a receiver is a measure of how well it reproduces the actual sound wave originating in the broadcasting studio. If a note of a certain loudness and frequency is sung into the microphone, then this note when reproduced by the loud speaker of the receiving equipment should be exactly the same both as regards wave-form, frequency and intensity. This should be true for any sound within the range that may be broadcast. In other words, a receiver that delivers a perfectly undistorted signal is one which has a uniform or flat frequency response curve.

-30-

## More Than 25 Proved Sales Promotion Services Help You Sell



WHEN you stock Sylvania Radio Tubes, you get the most comprehensive and effective merchandising service that ever helped a dealer to bigger profits.

Look over the partial list below. Many are free. Others are available at satisfying savings. All help you sell.

Write Hygrade Sylvania Corp., Dept. S60, Emporium, Pa., for samples of these selling aids and full information about the Sylvania way to bigger profits.

### Sylvania Helps . . . That Help You Sell

- |  |  |
|--|--|
| 1. Window Display Material (the TWA Display pictured above, dummy tube cartons, timely window streamers, etc.) | 14. Bill heads                               |
| 2. Counter displays  | 15. Service hints booklets                   |
| 3. Electric Clock signs  | 16. Technical manual                         |
| 4. Electric Window signs   | 17. Tube base charts                         |
| 5. Outdoor metal signs   | 18. Price cards                              |
| 6. Window cards  | 19. Sylvania News                            |
| 7. Personalized postal cards   | 20. Characteristics Sheets                   |
| 8. Imprinted match books   | 21. Interchangeable tube charts              |
| 9. Imprinted tube stickers   | 22. Tube complement books                    |
| 10. Business cards   | 23. Floor model cabinet                      |
| 11. Door Knob Hangers  | 24. Large and small service carrying kits    |
| 12. Newspaper mats   | 25. Customer card index files                |
| 13. Store stationery   | 26. Service Garments                         |
|  | 27. 3-in-1 business forms                    |
|  | 28. Job record cards (with customer receipt) |

## SYLVANIA

### SET-TESTED RADIO TUBES

Also makers of Hygrade Lamp Bulbs, Hygrade Fluorescent Lamps and Miralume Fluorescent Light Fixtures

## ASSURED STABILITY

WITH

### BLILEY CRYSTAL UNITS

10-20-40-80-160  
METER BANDS



**TYPE B5**—This highly active crystal unit for the 40 meter band has less than 4 cycles/mc/°C drift. Price \$4.80.

**TYPE LD2**—An efficient and powerful low drift crystal unit for the 80 or 160 meter band. Price \$4.80.

**TYPE HF2**—Simplifies the construction of 5-10- and 20-meter transmitters. Drift, 20 meters, 20 C/mc/°C; 10 meters, 43 C/mc/°C. Price, 10 or 20 meters, \$3.75.

**TYPE BC3**—A moderately priced mounted crystal with unusual activity and power output. Drift 23 C/mc/°C. Price, 40, 80 or 160 meters, \$3.35.

**BLILEY ELECTRIC CO. • ERIE, PA.**

## Testing F.M. Receivers

(Continued from page 13)

Next, if an r.f. stage is used, adjust the 1st detector shunt trimmer, followed by the adjustment of the r.f. stage shunt trimmer. Some sets do not have an r.f. stage, but use only 1st detector tuning. The 0-200 micro-ammeter serves as resonance indicator during this alignment process, reading grid current maxima as in the case of tuning the i.f. circuits.

Over-all response of the receiver tuned circuits may be checked by observing the grid current of the limiter while the signal generator is varied over the 150 kc. band-pass. This is done conveniently by tuning the generator to zero beat with a local frequency modulation station. The generator frequency is then varied plus or minus 50 to 75 kc. either side of the central frequency. The deviation of the value of grid current at plus 75 kc. should not be greater than the deviation at minus 5 kc. by more than 50%. In other words, symmetry of the response curve is sought about the station carrier axis, or equal side-band amplification in the receiver. If these side-bands suffer attenuation, there will be distortion of the wave due to nonlinear amplitude amplification. The flat-top curve is similar to high fidelity alignment in the broadcast band, with a sharp drop outside of the required pass-band. If this form of response is not obtained, the adjustments should all be repeated with pains-taking care and accuracy. If desired, before aligning the oscillator, 1st detector grid tuning and r.f. stages, the i.f. may be checked for symmetrical tuning by slowly varying the signal generator plus and minus 75 kc. about the 2100 kc. alignment frequency, or whatever i.f. may be used by a particular manufacturer.

The limiter action of the receiver is of great importance in suppressing noise and has the job of ironing out variations in amplitude of the received wave. If the limiter does not work properly there may be weak reception, distortion or noise. To check the limiter, connect the 0-200 micro-ammeter in the plate circuit with no signal input. Of course, it is assumed that the 6SJ7 tube has been carefully checked. Now, feed a signal between 40 and 44 mc. into the receiver input. Gradually increase the generator output until the plate micro-ammeter shows an increase. Continue to advance the generator output until the meter shows maximum plate current and then begins to level off, which will be the starting point of limiting action. Leaving the generator untouched, shift the micro-ammeter to the limiter grid return, seeing to it that the plate circuit of the limiter is reconnected after the meter's removal.

The grid voltage of the limiter will be indicated by the grid current multiplied by the grid resistance, usually about 25,000 ohms and 5 volts for 200 micro-amperes of current. If available, a vacuum tube voltmeter could be used to check the limiter input voltage across the high impedance grid circuit. In the manufacturer's data sheets, however, the normal plate voltage is given and may be checked with either a vacuum tube voltmeter or a

high resistance meter. If the plate resistance is measured, that is the load resistor, a current meter will give the current which may be multiplied by the resistance to obtain the voltage. The plate voltage of the limiter will depend on the sensitivity of the receiver, and may vary between 50 and 100 volts, depending on the manufacturer.

Service troubles are apt to involve defective tubes for the most part, as well as the usual run of difficulties common to all radios, whether f-m or otherwise. The antenna plays a very important role in achieving satisfactory results, since the limiter action is dependent upon a strong signal in order to work properly. If a tube before the limiter does not give enough gain, or there is any other weak link in the chain, noise and distortion may result. If a condenser opens up, either partially or completely, trouble may be expected in the way of regeneration which will sharpen the i.f. selectivity curve, cutting side-bands and resulting in only a portion of the 150 kc. band-pass being amplified, with resultant distortion. In the case of biased converter tubes, that is, automatic volume control bias, a certain amount of oscillator instability may result, which will show up in the need for retuning of the receiver. In such cases it may be advisable to use fixed bias of the mixer tube, removing the a.v.c. line. Where line voltage irregularities exist, incorporation of a VR-150 voltage regulator tube may be needed to stabilize the oscillator plate voltage.

Under certain conditions, i.f. interferences due to strong local stations may necessitate the use of a wave trap tuned to the peak frequency of the i.f. and placed in the antenna input circuit. Ordinarily, this won't be encountered.

Certain of the more elaborate f-m receivers employ high fidelity speakers with a range from 30 to 10,000 cycles or 15,000 cycles per second. Some, on the other hand, use smaller speakers which may cut off at about 7,500 cycles per second. For general purposes of testing, and to locate faults in the speakers or cabinets, such as rattles and resonant peaks, an audio generator equivalent to the RCA Beat Frequency Oscillator, rated at 30-15,000 c.p.s. with less than 5% r.m.s. distortion, is a worthwhile investment for about fifty bucks. Another means of testing, which has its merits, is the use of a high quality microphone which must be flat in response. Speaking or even warbling into it will give a good idea of the fidelity of the audio end of the receiver. The mike should be of the crystal type and high impedance for connection to the audio input. Feed-back of sound from the receiver's speaker, if the mike is used, should be avoided by turning the mike about on its vertical axis until a null point is found.

If the audio generator is used, a diode type rectifier voltmeter with as little frequency error as possible, should be shunted across the voice coil and the generator frequency varied throughout the range. The amount of amplitude distortion is then indicated by the meter, since the output should be substantially flat over the band of audio frequencies extending from 30- to upward of 10,000 c.p.s. Attention should be given to this end of the set,

## Speak-O-Phone QUALITY RECORDERS FOR 15 YEARS

Write for catalog.

## Speak-O-Phone Recording & Equipment Company

23 W. 60th St. New York City

**EVERYTHING  
IN RADIO**

This big book serves your entire needs. It includes sets, parts and supplies, public address, amateur equipment, testers, kits, fluorescent lighting. Nationally known favorites at lowest possible prices. Write today for your copy of this

**BIG FREE CATALOG**

**BURSTEIN-APPLEBEE COMPANY**  
1012-14 MCGEE STREET, KANSAS CITY, MISSOURI

## For Better Music Recording On Your Home Recorder



Outstanding velocity microphone for orchestras, stage and drama pickup, vocal and instrumental use. Small and compact. Does not hide performer's face. Highly pol. chrome finish. 25 ft. covered rubber cable. "Flex-tube" allows tilting of microphone into fixed position. Wt. 16 oz. Four impedances. Gives wider range. All highs and lows in true relation. "A recorder is no better than its microphone." At your jobber or dealer.

List \$24.50  
**UNIVERSAL MICROPHONE CO., LTD.**  
INGLEWOOD, CALIF., U. S. A.

as well as the tuned circuits, to secure best high fidelity performance. Many writers hardly mention the fact in speaking of f-m, taking it for granted that it will be done, this testing of the audio section.

In order that the reader may become better acquainted with the underlying theory and the development and practice of frequency modulation transmission and reception, the bibliography appended may be studied.

**Bibliography**

- Stromberg-Carlson Mfg. Co., Rochester, N. Y. Service Data.
- General Electric Co., Bridgeport, Conn. Service Data.
- Weston Pointer, Weston Elec. Instrument Co., Vol. 1, No. 6.
- Levy, p. 26, Electronics, June 1940.
- Hobbs, p. 22, Electronics, Aug. 1940.
- Olney, p. 32, Electronics, April 1940.
- Graham, Goodman, p. 11, QST, Jan. 1940.
- Rider, Frequency Modulation, Pub. 1940.
- Rider, Automatic Frequency Control Systems, Pub. 1937, pp. 20-52, et seq.
- Walter, F. W., RADIO NEWS, p. 10, May 1940.

**Underground River Tracer**

(Continued from page 15)

sachusetts Institute of Technology, and an ardent amateur, also responded.

James D. Brewer, Columbus attorney, came up from his home to offer his help. Clarence James, employe of a Columbus radio company, also was on hand.

McFerren descended to the seventh level of the cavern—165 feet below the surface of the earth.

Several thousand persons, including scientists, radio amateurs and curious spectators, watched the proceedings from the surface.

The principal direction finder was a home made goniometer.

This consisted of two aluminum rods, each one wavelength long. The rods were placed on a frame in parallel positions one-quarter of a wavelength apart.

The taps were taken one-quarter of the rod-length from one end. The frame was equipped with a suitable compass for the taking of bearings.

The receiving set was a standard commercial transceiver of conventional design.

The ball was launched and McFerren and the amateurs succeeded in picking up a strong tone. Bearings were taken every five minutes, and the direction was seen to change five or 10 degrees with each bearing.

After some time, the signal appeared to weaken and be interrupted, and this was attributed to a possible lowering of the cavern's ceiling, which would, of course, partially submerge the steel antenna, thus interrupting the signal. Weakening of the signal was blamed on the brushing of the antenna against the damp walls of the cave.

Amateurs listening to the tone said they got a definite "brushing" effect occasionally which convinced them that this was the case.

After about three-quarters of an hour the signal stopped, and the operators listened in vain for the tone. After a wait of almost an hour, the signal came in again. McFerren and his assistants took a bearing and, wasting no time, loaded the equipment into an automobile and started in the indicated direction—toward distant Lake Erie and the Blue Hole.

They took another bearing, and from the cross-references determined

that the ball must have stopped at a point 1.1 miles from the starting point. Later the signal stopped and did not again appear.

"From the action of the signal it was indicated that the ball hung up on the cavern several times," Cull said. "Then it apparently would break loose. The signal was a rather clear indication of the action of the ball—the brushing of the antenna, the ducking of the equipment, and the apparent remaining of the signal source in one location for a time all were clear indications of what was happening beneath the surface.

"There appears to be no doubt that the method is feasible and the experiment a success. However, it would be desirable for more amateurs to participate with directional antennae, to enable more cross-references to be taken. Many amateurs did not have time to prepare equipment for the experiment."

Results of the test, while not conclusive, seem to indicate that the belief that the underground river comes up at Castalia is sound, although what becomes of objects dropped in the cavern has not been explained.

The Blue Hole itself is somewhat of a mystery, as are the underground river and the Seneca Caverns, which were discovered some 60 years ago.

McFerren became interested in radio in 1910. W. K. Henderson, once widely-known operator of a station in Shreveport, La., became acquainted with him, and helped him build his first transmitter.

The blind man's call letters, W8FUO are known on three continents.

McFerren would like to put a small microphone in the next rubber ball he launches. The mike, he believes, would pick up noises in the cavern and indicate the nature of the bed and the size of the passages. He also will use more power on the transmitter.

**QRD? de Gy**

(Continued from page 35)

where the boat is to be converted into an ammunition carrier for the Navy. Naming of the vessel was rather appropriate, eh? It was to have become a merchant ship. If names mean anything this boat's sister ship, the *Sea Witch*, should go on Neutrality patrol! Catch on? If not, a 3c stamp will get you the answer. Reminds me that I've always thought the best name for a salvage tug should be "Eureka" because in the Greek language it's "I have found it," hi. Yes, the Greeks had a word for that, too.

**B**ROTHER LeRoy Brenner, *VWOA Los Angeles-Hollywood* reporter, sez . . . that Dave Sarnoff remarked at the recent luncheon tendered to him by the *VWOA*. "This is the only time I can remember when I have ever sat down and broken bread with all of my competitors, and where the spirit of good will and fellowship completely filled the air. It is, indeed, a wonderful thing in this day and age." . . . At the first *KGPL* civil service exams only six radiops showed up, so it was called off until they could circularize trade, high schools, etc. Results: 89 "school boys" showed up for the second exam. Job pays \$140 per and the exam was stiffer than the recent RI quiz. . . . Our Thanks to Tom Stevens for his gift of the choherer that was used by old Charles E. Ellsworth back in 1903. It'll go in our new "Wireless Shack." . . . Ye freezing Brothers get a load of this . . . Brother V. H. C. Eberlin, Sec. of the *VWOA-Miami*, writes—quote—it was more than a pleasure to entertain Steve Wallis this past week. After a cheery reunion on Miami's sun-flooded sands we

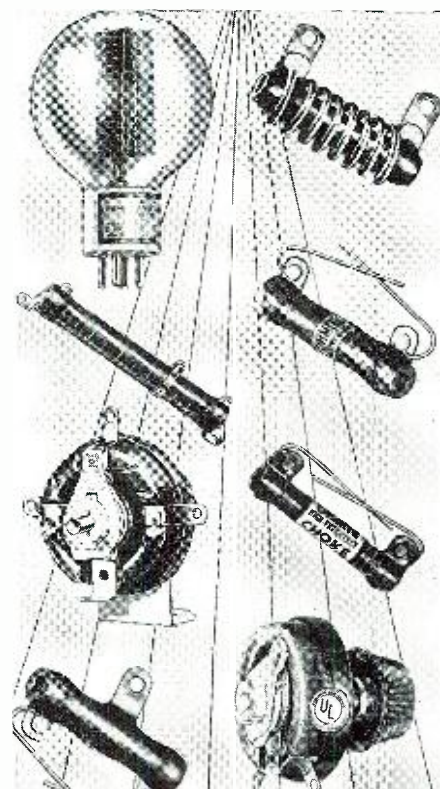

**OHMITE**

**Resistance Units**  
**Insure Best Performance**

Here are a few of the popular Ohmite Resistance Units used by Hams, Servicemen and Engineers for dependable, trouble-free performance in all climates of the world. See your Jobber or write for Catalog 17.

*Dummy Antenna in 100 watt and 250 watt sizes. Adjustable Dividohm Resistors from 10 to 200 watts. Band-Change-Switch for Rigs up to 1 K.W. 10 and 20 watt Brown Devil Resistors. Parasitic Suppressors. Center-Tapped Resistors. R. F. Plate and Power Line Chokes. Close-Control Rheostats from 25 to 1000 watts.*

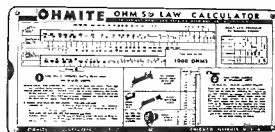

**NEW!**  
**OHMITE**  
**OHM'S LAW**  
**CALCULATOR**

Solves any Ohm's Law problem with one setting of the slide! No slide rule knowledge required! All direct readings. Only 10c to cover handling cost. At your Jobber or send coupon.

**OHMITE MANUFACTURING CO.**  
4884 Flournoy Street, Chicago, U. S. A.

10c in Coin enclosed. Send Ohm's Law Calculator. (Please Print Clearly)

Name.....  
Address.....  
City.....State.....  
Occupation.....

*Radio News—Feb.*

**RADIO ENGINEERING**  
DEGREE IN 2 YEARS

• Complete Radio Engineering Course in 2 1/2 years. Bachelor of Science Degree. Radio (television, talking pictures and the vast electronic field) offers unusual opportunities for trained radio engineers. Courses also in Civil, Electrical, Mechanical, Chemical, Aeronautical Engineering; Business Administration and Accounting. Tuition, living costs low. World famous for technical 2 1/2 year courses. Special preparatory department for those who lack required high school work. Students from all parts of the world. Enter March, June, September, January, 58th year. Write for catalog.

1621 COLLEGE AVE. ANGOLA, IND.

**TRI-STATE COLLEGE**

**LANGUAGES**  
Made *easy* By  
**LINGUAPHONE**

This amazing new Method enables you, in your own home, to speak and read any of 27 foreign languages in an incredibly short time. Endorsed by leading university professors and thousands of men and women as the quickest, simplest and most thorough language method.

SEND FOR FREE BOOK

**LINGUAPHONE INSTITUTE**  
83 RCA Building New York City

**RADIO-TELEVISION**

Oldest, largest Radio-Television school in West trains you for good pay job. Complete instruction including Radio Construction and Service, Broadcast Operating, Sound, Talking Pictures, Television, Public Address, etc. Flexible plan to meet specific needs of those with or without jobs. Transportation allowed to L. A. Earn room and board while learning. Request Free Catalog.

Dept. RN-2  
Los Angeles

**NATIONAL SCHOOLS**

**RADIO ENGINEERING**  
DEGREE IN 2 YEARS

Intensive, specialized course, including strong basis in mathematics and electrical engineering, advanced Radio Theory and Design. Modern laboratory. Low tuition. Self-help opportunities. Also 2-year courses in Aeronautical, Chemical, Civil, Electrical and Mechanical Engineering. Participation in Civilian Pilot Training Program. Enter March, June, September, December. Catalog.

**INDIANA TECHNICAL COLLEGE**  
721 E. Washington Blvd., Fort Wayne, Ind.

**RADIO ENGINEERING,**  
broadcasting, aviation and police radio, servicing, marine radio telegraphy and telephony, Morse telegraphy and railway accounting taught thoroughly. 48 weeks' Engineering course equivalent to 3 years of college radio work. All expenses low. Catalog free. School established 1874.

Dodge's Institute, Oak St., Valparaiso, Ind.

**RADIO COURSES**  
Mid-Term Classes Now Starting

**RADIO OPERATING—BROADCASTING**  
• RADIO SERVICING—a practical course  
• RADIO AMATEUR CODE • TELEVISION  
• ELECTRONICS—1 yr. day course, 2 yrs. eve. Day and Evening Classes. Booklet Upon Request.

**New York Y. M. C. A. Schools**  
7 W. 63rd St. New York City

**RADIO TECHNOLOGY**

**RCA** Institutes offer an intensive course of high standard embracing all phases of Radio and Television. Practical training with modern equipment at New York and Chicago schools. Also specialized courses in Aviation Communications, Radio Servicing and Commercial Operating. Catalog Dept. RN-41.

**RCA INSTITUTES, Inc.**  
A Radio Corporation of America Service  
75 Varick St., New York 1154 Merchandise Mart, Chicago

spent a number of enjoyable hours atop the Blackstone Hotel, at the Roof Garden. Also in the party were Mr. and Mrs. J. Summers who, more than a few times have attended the New York Annual Cruise. . . . To say that our pleasure will be supreme with an autographed photograph of Dr. DeForest is putting it mild. We eagerly await its arrival for our club rooms. . . . David Harpley just recently was married to a most charming miss. Long life and a smooth voyage down the years to come. . . . Ches. Corrigan, our chapter chairman, recently returned from a trip to St. Louis. . . . Eastern Airways, Miami, is looking for good radio-men, technical and otherwise. **WOAM**, Miami, is contemplating FM. **WIOD** will soon install a 5 KW'r. It is creating a new island in Biscayne Bay on which a new studio will be erected. . . . With Miami moving into its seasonal activity we look forward to many an enjoyable get-together with incoming **VWOA**'ns. Ye sec can be reached thru **Tropical Radio**, Miami. It would be interesting to hear some stories from brother ops who have been shipping in and around the war zones. . . . Ed Jones, eng. Prod. Promotion of **RCA**, Camden, N. J., also writes to say, "x\*x&xcg\* . . . X h'n;x, etc., 73, and adds best 73 to "Abe Lincoln" Jackson and Bill Beltz. Ed. is a real veteran, having begun his career back in 1909. . . . Who's where and why. . . . Dave Kennedy and Jim Wright who have been doing summer relief work at KFI-KECA are now on the beach. . . . Sid Minnikin and John Tutt, ex-KMTR, are now at KIEV. . . . L. Winsler, Chief at KOK, has been called to active duty as Communications Officer on one of the Pacific battlewagons. . . . Geo. Voder is standing the mid watches at KFWB. . . . Howard Grove, ex-chief eng. of Sound Products, is now a civilian procurement inspector for the Signal Corps in Oakland. . . . Kenneth Isbell, ex-KFI and KEHE, has been temporarily with KGPI, as op-announcer while awaiting results of Civil Service exam. . . . Charlie Cross and Sid Brown are now on the SS *Mariposa*. . . . Francis Brown is the proud papa of a 7 lb. girl, every one doing fine, including Brownie. . . . Final **50**: George Seward of Television fame has gone to a just reward—May God rest his soul.

**B**ROTHER Gilson Willets, who held number one membership in the **VWOA**, had some very interesting stories to tell when ye ed saw him in Frisco recently. One of them being the one about how the **VWOA** first started. He sez that Hugo Guernsback, erstwhile publisher of **RN**, put up the money necessary for coffee and doughnuts so that the brothers would have something to chew besides the fat. It was this impetus which caused the **VWOA** organization to bring together oldtimers for annual reunions so that comradeship and good cheer would keynote reminiscences. Brother Willets has strayed from the path of radiowork into the highways and byways of newspaper writing, plus an occasional book. We herewith wish him luck and hope that rejection blanks will be few and far between.

**S**O we pray that if our ships do carry supplies to the Allies they will be spared the fate of those that have gone down to the deep. But the work must be done to save that which we hold dear, so let's do it to the best of our ability and may Fate guide our way. So with 73 . . . ge . . . GY.

**Cuttings**  
(Continued from page 26)

ing is to be made the "Outside-in" scale is used in place of the one above. The scale may be removed by pressing to the right (front view) and lifting the scale out, left end first.

As described above, the feed screw is driven by means of a friction wheel disc assembly, which in turn is driven by means of a clutch. This provides a positive drive, but will allow the feedscrew to be turned faster (by the handwheel) than the normal drive speed. By this means, "spirals" may be cut for the purpose of separating several recordings on the same record, or to provide a lead-in spiral for starting. "Complete spi-

ral" or circles may be cut by lifting or disengaging the feed lever, observing the operation carefully to prevent too deep a cut.

Mounted alongside the turntable is an adjustable arm, on which is assembled a microscope. The microscope may be moved over the entire surface of the record, making it possible to observe any part of a recording. The microscope should always be used to observe the depth of cut, as is explained later. A small lamp is also mounted onto the adjustable arm, and is made independently adjustable so as to illuminate the record grooves under observation. A switch for turning this lamp "on" and "off" is mounted on the turntable mounting board assembly.

A desk type lamp with a long flexible "gooseneck" is mounted on the back top of the equipment. This lamp may be moved over the turntable to any desired position, and may be moved high enough to illuminate the entire top of the turntable mechanism. This makes it possible to observe the record as it is cut, and the operation of the entire recording mechanism.

Facilities for mounting a pickup and tone-arm onto the turntable assembly are provided. A round cover plate will be found on the right forward side of the equipment. By taking out three machine screws this cover plate may be removed, and the pickup arm assembly may then be mounted into place. For best results the MI-4875-A Combination Pickup and Arm is recommended. This high fidelity pickup may be operated on either lateral or vertical cut records.

The RCA MI-4894 Automatic Recording Equalizer is designed to compensate for the gradual decrease of high frequency response as the center of the record is approached. This loss of high frequency response is caused by the decrease of record surface speed as the center of the record is approached. By using the MI-4894 Automatic Recording Equalizer (MI-4913-3 Mounting Bracket) when recording a record, the high frequency response through the amplifier system is gradually boosted as the cutter nears the center of the record.

—50—



Official photograph U. S. Army Air Corps

**CAMERAS BUILD OUR AIR FORCE**

Photography is being put to startling new uses in our National Defense program. To give America the superiority in the air that she seeks to have within the next 3 years, it is necessary to determine the best metals, fuels, fabrics, and other vital materials which are to go into our new fighting planes. Don't fail to read how the camera is doing the job as it's never been done before. You'll find this timely article in the big

**FEBRUARY ISSUE**

**Popular Photography**

**NOW ON SALE at all newsstands!**

**Bench Notes**

(Continued from page 19)

cause the same trouble, not to mention a few dozen other points such as defective resistors, tubes and connections.

Another perennial favorite is the one about oscillation being caused by an open screen by-pass condenser. Anyone who makes a pretense of being a service man should know that this is one of the first points to check when oscillation is experienced, hence there is no reason this should be published year after year as a "service tip."

On the other hand there are bona-fide service notes of real value, and we would like to devote a small space each month to such items, if our readers will send them in. We hope none of the foregoing will discourage those men who have such tips as will be of real benefit to others.

**A Little Double Dealing**

At the outset let us say, don't let the above caption fool you, we are not going to advocate any low skullduggery for bamboozling the trusting customer, but present a two-way system of bidding on jobs, that should make more money for the service man, and more satisfied customers as well.

In a recent issue we aired a few thoughts on service responsibility and guarantees, and closed with a request for methods of others. That "man of parts" Harold Davis, in Jackson, Mississippi, was good enough to take time from his multifarious duties, and send in details of a practical working plan that is being used successfully in his district, which we are happy to present in this department. Part of Mr. Davis' letter follows:

*"When a set is taken in the shop for an estimate it is first examined for the last thing that happened to it to make it quit playing. A price is fixed on this, which is called a patch job. Next the set is gone over thoroughly and notes made on everything that could be done to improve its performance. After this is done a nice margin of profit is added, and regardless of what the figure runs it is set down as an overhaul estimate."*

*"When contacting the customer the overhaul price is given him first. It is to be expected he will hit the ceiling, but the service man must not be alarmed and must turn loose a good selling talk. He (the customer) must be reminded that the set has given him several years good service, if this is the case, and that with this overhaul job it can be expected to give some more good service. When mention is made of the nine-ninety-fives that can be purchased, the service man must snap back with a quick reminder that dollar watches can also be purchased. This one statement is easily self-explanatory. If it is impossible to get the overhaul job, the service man then gives the customer his estimate for the patch job. This should be a very reasonable price, and it should be thoroughly understood that no guarantee whatsoever goes with it."*

*"This system does two things. First it is surprising how many big jobs can be obtained through it. Second, it practically eliminates the kick-backs, because if the customer takes the*

# Sound System Men Praise Airline SOUND SYSTEMS

You can depend upon the opinion of men who *know* sound systems and who insist upon sound system performance. Here is what a few of them say about the Ward Airline: "Working perfectly—no repairs of any kind!" "Big volume—tone clear and natural!" "Customers greatly pleased at uninterrupted service!" "Natural tone and large coverage!" "Installed amplifier in tower of large church; was heard nearly 4 miles in the country!" "Most natural I ever heard in tone and range!" And hundreds more along the same line! Remember that due to Ward's direct selling plan, no other sound system could produce such results at anywhere near the price of the Ward Airline.

**WRITE FOR CATALOG**

The new Ward Catalog gives you important facts about Sound Systems . . . what you can expect from an Airline; what speakers, amplifiers and mikes to select for best results; how everything plugs together, providing utmost simplicity in setting up and taking down. Mail coupon for FREE copy!

**TIME PAYMENTS 15-DAY TRIAL  
MONEY-BACK GUARANTEE**

**Montgomery Ward**  
9 GREAT MAIL ORDER HOUSES  
MORE THAN 600 RETAIL STORES

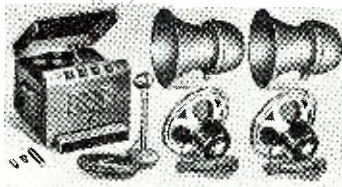

**RUSH FOR  
FREE CATALOG**

MONTGOMERY WARD & CO.

Dept. RN-42, Chicago, Ill.

Please send your Airline Sound System Catalog at once.

Name \_\_\_\_\_

Address \_\_\_\_\_

State \_\_\_\_\_

## COMPLETE RADIO COURSE \$1.95

HOW 8,749 RADIOMEN OBTAINED THEIR TRAINING

**HELPS YOU GET  
A RADIO JOB**

"The radio training course is the finest, up to date, easy to understand course . . . This course outlines practical work. We are using this course in our Topeka High School. It is wonderful." Henry Ward, Jr., Topeka, Kansas.

"You should get more money for the R.T.I. Course. The first week I studied it. I made \$10.00 repairing sets. I built my own test outfit from details given in this course. I have repaired 100 radios to date . . ." Robert C. Hammel, Davenport, Iowa.

"I am very satisfied with the course. When I was at the twelfth lesson I started to repair radios. It took me two months to master your course." Roger Lanzlois, Montreal, Canada.

"I have found since taking your course how modern and up to date it really is. There is not one page in the whole course which anyone interested in radio can afford to miss. Your course started me on the road to a well paid job and has repaid me many times." Charles A. L. P. a c h., Reading, Pa.

You may also get exact reprint of the regular \$39.00 Radio Technical Institute course for only \$1.95 the full price. The course is complete in every way and exactly the same as higher priced original lessons.

**AMAZING REDUCED PRICE**

Learn to repair all radio sets expertly. From the very start you are introduced to practical equipment and methods. A single time-saving hint will more than pay for the special \$1.95 price for the complete course and all supplementary material. Tells you how to become a first class radio serviceman with easy to follow lessons.

**FOR HOME-STUDY**

Get ahead in Radio with this complete training. No special education or previous experience required. The streamlined lessons are clear, interesting, easy to understand and use. A final examination and diploma available after course is finished. Special \$1.95 price for the entire radio course can be earned the first hour of radio work.



**LESSONS ON**

Every phase of radio including television, P.A., troubleshooting, short-cuts in servicing, essential theory, practical construction, and all other important branches.

**EVERYTHING ABOUT RADIO**

Reprinted in 1940, with added facts on signal tracing, F. M., television, photocells, and every other important development. Forty-three radio manufacturers helped to prepare this course. This training will give you data you need on the job. Limited quantity of courses printed. Look the lessons over in your home without any risk.

**10 DAYS' FREE EXAMINATION**

SUPREME PUBLICATIONS, Room 534, 3727 W. 13th St., Chicago, Ill.

Ship the complete course on approval without any obligation to buy. I may keep the course for 10 days. If, for any reason, I am not pleased, you guarantee to refund my money.

I will pay \$1.95 and 13c postage to the postman.

I am sending \$1.95, the full price, ship postpaid.

Name: \_\_\_\_\_  
Address: \_\_\_\_\_

**REWARD  
FOR TRAINING**  
-Better Jobs!  
-Increased Salaries!

CREI trained men are well rewarded for their earnest ambition to succeed in Radio. Surveys disclose that CREI graduates, as a group, are among the **HIGHEST PAID IN RADIO** . . . 69% enjoy **SALARY INCREASES** during or immediately after their training!

If you are no longer content with your present progress in radio—if you are anxious to advance to the better radio job you KNOW should be yours—now is the time to investigate the opportunities that await you through CREI training in advanced Practical Radio Engineering. **5,000 RADIOMEN CAN'T BE WRONG!** They're the men who have already turned to CREI for the advanced training they realized is necessary for success. Can't we help YOU?

### WRITE US TODAY

If you are a professional radio-man and want to make more money—let us prove we have the answer to your problem. Our free booklet gives complete details—without obligation. To help us intelligently answer your inquiry—please state briefly your education, radio experience and present position.



Free Booklet  
Sent

## CAPITOL RADIO ENGINEERING INSTITUTE

Dept. RN-2, 3224-16TH ST. N. W., WASH., D. C.

## RADIO OPERATORS WANTED

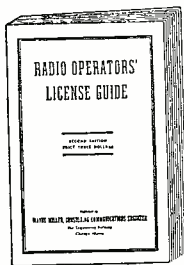

The National Defense Program is creating innumerable openings for Commercial Radio Operators—Now is the time to capitalize on your radio training and experience by obtaining a commercial operator's license and taking advantage of the many opportunities presented—The "RADIO OPERATORS' LICENSE GUIDE" has been especially prepared as a study and reference manual for those radiomen having considerable training and experience who are unfamiliar with the exact requirements for a commercial radio operator's license—Containing over 1,250 questions and answers to the new type examinations it will aid you to successfully pass the examination—Only three dollars postpaid—Send check or money order.

**WAYNE MILLER**

The Engineering Building • Chicago, Ill.

patch job he is well informed that there are many other things that the set needs. If he takes the overhaul job, and a good job is done, there should be very little kick-back, but even if there is, the service man has a substantial margin of profit to enable him to take care of it. I recommend that the overhaul job carry at least six months' unconditional guarantee and charges should be made accordingly."

This is a somewhat different method of handling the "bounce-back" problem, and a very good one too, as in addition to protecting the serviceman from unreasonable demands from customers who have only paid for some minor repairs, it greatly increases the service man's prospects of getting a worthwhile service job out of the call. This is a very important feature, as too many service men have let the low priced receivers influence their estimates on repairs to a point where they hesitate to quote any price over \$5.00. A little well-directed conversation will prove that many customers who have receivers originally costing more than \$100 are generally most contemptuous of the small table models so popular today, and the service man need not be surprised when he finds these people willing to spend more than \$9.95 on a radio.

That this is not merely theoretical we know as it is in line with our experience. As a specific case; just recently our shop brought in a four-year-old Stromberg-Carlson, whose original cost was \$350. The owner agreed with us there was no point in doing a make-shift job, and since they had always liked the receiver agreed to a complete overhauling, with the result that a bill for \$38.00 was presented and paid without demur. It is needless to point out that we did not let the cost of a cheap midget have anything to do with fixing our price on the Stromberg.

So keep your mind on the set you are checking, and ignore the cheap midgets, but if your customer insists on reminding you of them, don't forget Mr. Davis' *bon mot* (snappy crack, to you) that "you can buy dollar watches, too." —30—

### Legal Advice

(Continued from page 29)

real" and is not real estate.<sup>8</sup> It follows that the lease being "personal property," the mortgage upon it is a personal property mortgage, and the action is for the foreclosure of a mortgage on personal property.<sup>9</sup>

#### Use of Roof for Advertising Purposes

In *Reynolds vs. Van Beuren*<sup>10</sup> and advertiser was given the right to go upon a roof of a building and place advertisements upon a sign. The Court held that although the instrument creating this right was called a "lease," it manifestly was nothing more than a mere license. It conveyed no estate or interest in the realty and no possession or right of possession to the building or any part of it.

#### Possession

A landlord has no right to enter on his tenant's premises during the term of the lease without the tenant's consent.<sup>11</sup> On this point, *Blackstone* in his *Commentaries* on the Laws of England said that a man's home is his castle; that the wind may enter, the snow may enter and the rain may enter but the King of England dare not place his foot across the threshold.

Actual possession of real estate by a tenant is sufficient notice to a person proposing

to take a mortgage on the property, and to all the world, of the existence of any right which a person in possession is able to establish.<sup>12</sup>

#### Creation of Leasehold Estate

No particular words are necessary to constitute a lease, where it appears that it was the intention of one party to dispossess himself of the premises and of the other to enter and occupy as the former himself had the right to do.<sup>13</sup>

If a written lease is subsequently to be drawn up, and it is left until then to agree upon some of its terms and conditions, there is no leasing. But if the terms are all agreed upon and nothing more is to be done, except to reduce them to writing, the contract is complete, even though the writing is never drawn up. However, a lease for a term exceeding one year must, as a rule of substantive law be in writing subscribed by the lessor or his agent. So also, the agreement to make the lease for a term exceeding one year, or a note or memorandum thereof must be in writing subscribed by the lessor or his agent. In other words, a parol lease for more than a year is void.

<sup>1</sup> Stern vs. Equitable Trust Company, 238 N. Y. 267.

<sup>2</sup> Steward vs. Briggs, 138 App. Div. 701 (N. Y.).

<sup>3</sup> Tilyou vs. Reynolds, 108 N. Y. 558.

<sup>4</sup> Bennett vs. Austin, 81 N. Y. 308.

<sup>5</sup> Benjamin vs. Benjamin, 5 N. Y. 383.

<sup>6</sup> Bedford vs. Terhune, 30 N. Y. 453.

<sup>7</sup> Kavanaugh vs. Cohoes, 114 Misc. 590.

<sup>8</sup> People vs. Bennett, 14 Hun 63 (N. Y.).

<sup>9</sup> Lembeck & Betz vs. Sexton, 184 N. Y. 185.

<sup>10</sup> 155 N. Y. 120.

<sup>11</sup> Bank vs. Pierce, 161 Misc. 756.

<sup>12</sup> Phelan vs. Brady, 119 N. Y. 587.

<sup>13</sup> Canton vs. Duffy, 200 App. Div. 306.

<sup>14</sup> Peer vs. O'Leary, 8 Misc. 350.

### Recording Studio

(Continued from page 26)

siderably from the normal flat response of the amplifier and the greatest peak volume is at 4000 cycles.

The second part seen on the disc was cut with the bass frequencies cut off below 200 cycles and the highs attenuated above 800 cycles. Comparison with the data kept on this disc shows that the frequencies above 1000 cycles fall in level to that of the disc and are completely missing when the record is played back. This cut was made to illustrate the effect of peaking at 300 cycles without the extreme high and low notes. The listening test of this test will discourage the music lover no end.

The outside cutting is at 1000 cycles, similar to that on Fig. 2. Here we used steps of 1 db. instead of 2 db. This gives a sort of crescendo effect to the note and the action may be observed readily. The maximum cutting level was +18 db. at the head.

Next we come to the patterns illustrated in Fig. 4. These are rather unusual in some respects and were made to illustrate the effect when notes are cut at various amplitudes. This test record is divided into two parts: The first cutting (inside) was made as follows: Frequencies of 50, 100, 200, 300, 400, 500, 600, 700, 800, 900 and 1000 cycles were cut, each at three volume levels, +18 db., 14 db., and 10 db. Observe the heavy pattern left in the 50 cycle grooves and note how the taper widens as the volume is increased. This is more clearly illustrated on the rest of the cuts from 400 cycles on up. This test shows excellent uniform response from 400 cycles to 1000 cycles, in fact it is safe to state that this is within ½ db. The test could have been

continued for the remainder of the available space and the pattern would indicate the response over whatever range we decide to use.

The remainder of the record was cut at 200, 400, 300, 100, 50, and 25 cps. at a level of +18 db. while the outside straight-sided cuts are 400 cycles at +18 db. as a reference. Note that the response falls off at 50 cycles which is normal without any boost. These cuts are to be used for low-frequency reference standards and therefore no treatment was wanted.

The test disc illustrated in Fig. 5 was cut at "constant amplitude" with a Brush RC1 crystal cutter. Here we find excellent response up to 10000 cycles as shown by the uniform pattern width. There is a 2 db. peak at 8000 cycles due to the employment of an equalizer that was added to increase the high-frequency amplitude at that point. The frequencies above 10000 cycles fall off rapidly down into the noise level. This pattern represents an almost ideal condition and the playback will show a nearly flat response if the amplifier is capable of reproducing the entire frequency range.

The next article in the series will be devoted to an explanation of both "Constant Velocity" and "Constant Amplitude" recording and the advantages and disadvantages of both.

**Aviation Radio**

(Continued from page 22)

soon as the old course is left behind.

Dr. Luck is chiefly responsible for the new system after four years of development at RCA's aviation radio laboratory at Central Airport, Camden, N. J.

Known as the omnidirectional radio range

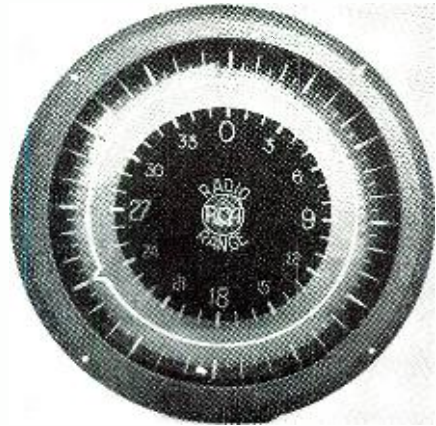

beacon, the new instrument operates in the ultra-high-frequency wave lengths, avoiding static and achieving greater reliability in storms or other atmospheric disturbances, Dr. Luck told the engineers.

"The present aviation guidance equipment on long waves gives only four paths in which navigation can be carried out," Dr. Luck said. "But if the pilot wishes to fly off the regular course, or beam, he must carry through a complicated sequence of maneuvers to determine his exact position. In order to supplement the range, then, direction finders are used, to show the direction of the beam transmitting station from the plane."

He explained that aircraft direction finders are not satisfactory in the ultra high frequencies, so that in order to obtain static-free navigation in these frequencies a new system was developed.

"We have worked out a range which marks paths in all directions, reducing the need for a direction finder or radio compass," Dr. Luck said.

-30-

**Video Reporter**  
(Continued from page 32)

area. But there was one thing about it that they couldn't enjoy. It wasn't an RCA job. It belonged to the Allen B. DuMont Laboratories!

Incidentally, DuMont has continually done an envious promotional job.

So there was RCA, with a splendid record of television pioneering just standing by while other firms kept themselves before the public eye.

Hence—as these lines are being written—RCA-NBC is back in television action.

But this much is certain: No longer will the Radio City video set-up get exclusive attention. There are alert and active competitors in the field—a healthy thing for all concerned. And the one who will benefit the most out of the competition is the look-and-listener who is bound to have the advantage of constantly improved offerings from a few local video stations trying to outdo each other.

-30-

**Book Review**  
(Continued from page 40)

in continental U.S.A., \$1.50 elsewhere; buckram bound, \$2.50. Spanish edition, \$1.50.

FESSENDEN, BUILDER OF TOMORROWS. By Helen M. Fessenden. Published by Coward-McCann, Inc., New York, N. Y. 362 pp. including index. Price \$3.00. This excellently written book takes the reader through the progress made by that great engineer, Reginald A. Fessenden. The writer, Helen M. Fessenden, in her

foreword says, "To the world of today and the world of tomorrow, worlds alike benefited and enriched by the life of Reginald A. Fessenden, I give the man himself. That the mind which conceived the correct theory of wire-

**ELECTRICAL BOOKS**  
shipped **FREE**

**10 BIG BOOKS** FOR **EXAMINATION**

**MODERN ELECTRICITY**  
INCLUDING RADIO and TELEVISION

Here's great news for anybody interested in Electricity. 17th edition of Applied Electricity brought right down to date with NEW Electrical subjects well covered. 10 big Volumes all shipped **FREE** for examination.

**FOR BEGINNERS and EXPERTS**

Over 3000 pages—hundreds of illustrations. Dynamos, motors, power stations, radios, television, everything electrical explained so anyone can understand it.

**FOR BEGINNERS and EXPERTS**

Men who understand electricity are needed in thousands of industries. Autos, airplanes, machine shops—practically every industry demands an electrician and men who know this subject make big money. Pleasant, fascinating work, easy to learn and do. Learn with these books. Send coupon for a set for **FREE** examination and see for yourself.

**SEND NOW!** A year's consulting privileges to all buyers of this famous Cyclopedic of Electricity.

**AMERICAN TECHNICAL SOCIETY**  
Publishers—Home Study Course

American Technical Society, Dept. E222, Drexel at 58th St., Chicago

Send for 10 days' use, 10 volume set of Applied Electricity. You agree to include a certificate entitling me to consulting privileges for one year. I will pay the delivery charges only on the books. If I wish, I may return them in 10 days and owe you nothing, but if I keep them, I will send \$2.00 after 10 days, then \$3.00 a month until the total price of only \$29.80 is paid.

NAME.....

ADDRESS.....

CITY..... STATE.....

Please attach letter stating age, occupation and name and address of employer and give at least one business man as reference.

**"HAVING A SWELL TIME" WRITES ABNER BUGLE, "WISH YOU WERE HERE"**

Abner Bugle is the man who used to write the advertisements for Sprague Condensers.

Nobody could juggle adjectives more gracefully than Abner and when it came to slapping on the superlatives, even Abner admitted he was just about tops in his profession. But Abner ran into a snag one day, and here is how it happened:

"Look, boss," he wailed to the president of the advertising agency for which he worked. "I'm in a helluva fix. There's nothing more to say about Sprague Atom midget dry electrolytic condensers."

"What!" roared the president, gnashing his teeth so hard he bit the stem off his Meerschaum. "Don't be a fool, Bugle! Why, Atoms build up quicker. They stand higher surges. Their low leakage avoids overheating. They're smaller, and they've got more guts than—"

"I know all that," mourned Abner. "But every cheap condenser makes just about the same claims—whether they can live up to 'em or not. They may not be as good as Atoms in a radio set, but they look just as good in an ad. I don't know what to do."

"Jeepers Creepers, man!" the president's bellow shook the oil painting of the 50th million Sprague TC Tubular hanging on the wall. "And you say you're an advertising expert! Of course Atoms are better. They're unconditionally guaranteed. There isn't a firecracker in a carload—not in a trainload—two trainloads—three trainloads—"

"I know that, boss," wailed Abner. "But you can't PROVE those things in print. No



matter if he fills 'em with mush and wraps 'em in tissue paper, another manufacturer might CLAIM that his condensers are as good as Atoms."

The president did not reply. Grasping pad and pencil, he suddenly began to write. For two hours, Abner stood by, pale and wan and there was no other sound save the feverish scraping of the boss' gold pencil.

"Eureka!" shouted the president finally. "I've got it. Here's what we'll say in our next ad. Listen to this:

"We're glad most condensers are bought on the basis of hard-boiled engineering tests rather than mere advertising claims. When quality is allowed to speak for itself, there can be no mistaking what it says. That's why Spragues are today specified by leading users throughout the world."

"Splendid copy, boss—and it's all true," said Abner, breathing a deep sigh of relief.

"Splendid nothing!" shouted the president. "It's perfect. What's more, you're fired, Bugle. In the future, I'll write the Sprague ad myself."

**SPRAGUE PRODUCTS COMPANY**  
North Adams, Mass.

P.S.—When last heard from, Abner Bugle had become a beachcomber in Tahiti. "Having a swell time—wish you were here," was what he wrote on the postcard, and added: "It's a great life. Beats advertising to a frazzle."

Advertisement

less transmission, which invented the wireless telephone and with it accomplished the first broadcasting, which invented and developed the Fathometer and all it implied, that this mind

## Classified

Rate 15c per word. Minimum, 10 words.

### A. C. GENERATORS

110 VOLT A. C. Automobile generators. Easily installed. Perfect performance. Operates amplifiers, movies, etc. LeJay Manufacturing, 151 LeJay Bldg., Minneapolis, Minn.

### BUSINESS OPPORTUNITIES

**INDEPENDENCE**—no bosses. Make money. Your own business manufacturing candy, popcorn, potato chips, food specialties, using home grown farm products. We furnish cookers, cutters, beaters, simple instructions, advertising material, selling plans. Small investment. Adequate profits. Write Long Eakins, 2092 High St., Springfield, O.

### CONSULTATION

LET a graduate electrical engineer help you solve your radio or electrical problems, large or small. Satisfaction guaranteed. Write details for price quotation. William Hayes, Box 1433, Oakland, California.

### CORRESPONDENCE COURSES

**AMATEUR** Radio licenses, training in code and theory. Resident and home study courses. Hundreds of licensed students. American Radio Institute, 1123 Broadway, New York.

**USED** Correspondence Courses and Educational Books sold or rented. Inexpensive. Money-back guarantee. Write for Free Catalog listing 4000 bargains. (Courses Bought.) Lee Mountain, Pisgah, Alabama.

**CORRESPONDENCE** courses and educational books, slightly used. Sold. Rented. Exchanged. All subjects. Satisfaction guaranteed. Cash paid for used courses. Complete details and bargain catalog free. Nelson Company, 500 Sherman, Dept. B-237, Chicago.

### PATENT ATTORNEYS

**PATENTS**—Advice and booklet free. Highest references. Best results. Promptness assured. Watson E. Coleman, Patent Lawyer, 724 9th Street, Washington, D. C.

**PATENTS** secured. Two valuable booklets sent free. Write immediately. Victor J. Evans & Company, 429-B Victor Building, Washington, D. C.

**INVENTORS**—Before disclosing your invention to any one send for Form "Evidence of Conception"; "Schedule of Government and Attorneys' Fees" and instructions. Sent free. Lancaster, Allwine & Rommel, 414 Bowen Building, Washington, D. C.

**INVENTORS**—Don't delay. Protect your idea with a Patent. Secure "Patent Guide" and "Record of Invention" form—FREE. Preliminary information furnished without obligation. Write Clarence A. O'Brien, Registered Patent Attorney, 1B17 Adams Building, Washington, D. C.

### PHOTOGRAPH RECORDS

**PHOTOGRAPH** Records 10c. Catalogue. Paramount, FB-358 East Market, Wilkes-Barre, Pennsylvania.

### PHOTO FINISHING

**ROLLS DEVELOPED**, two prints each and two free enlargement coupons, 25c. reprints, 2c each; 100 or more, 1c. Summers Studio, Unionville, Mo.

### RADIO ENGINEERING

**RADIO** Engineering, broadcasting, aviation and police radio, servicing, marine and Morse telegraphy taught thoroughly. All expenses low. Catalog free. Dodge's Institute, Elm St., Valparaiso, Ind.

### RADIO

**WE** buy and sell used radio testing equipment. Harold Davis, Inc., Jackson, Miss.

**RADIO** Kits—\$3.95 up. Single band; all wave, 5-10 tubes. Fluorescent lighting. Save 50%. Radio-paris catalog—FREE. McGee Radio, P-2075, K. C. Mo.

### RADIO SUPPLIES

**CONDENSERS**, 1c up. Tubes 10c. Free lists. Potter, 1314-R McGee, Kansas City, Mo.

**HEY, LOOK!** Something every radio dealer and service man should have. Take a chance. There is something you don't know about radio tubes. Send one dollar for rejuvenator. Money back, if not satisfied. Vance Lind Radio Service, St. Paul, Nebr.

failed to defend itself against commercial assault, whether financial or scientific, is an inescapable fact. For this fact I make no apology. Mine is the setting forth of factual data, and indication of trends, not the indictment of any man or group of men. Without a straightforward account of certain legal encounters, the life of my husband could be but partly told. The outcome of these encounters is a matter of court record which 'he who runs may read.' It is, however, not by court decisions but by his work that the man will be remembered." This book will be of interest and value to those engineers and students who are interested in the history of radio from its inception. Price \$3.00.

### Ring the Bell

(Continued from page 37)

taining that the trouble is in the radio set, he picks it up, leaving a small table model in its place and promising 24-hour repair and delivery. We ask for an estimate which costs \$1.00. The \$1.00 also includes the cost of the service call.

At 9:00 A.M. the next morning, we are advised of the cost of repair. Our yesterday afternoon caller had brought the set into the branch office where it, along with dozens of other receivers, was transported across-town to the main repair shop. The night crew estimated the cost of the repair. We agreed to the repair charge (which was substantial) and after the day crew repaired the receiver it was returned to the branch shop and to us in the early evening. As we desired to pay on the first of the next month, we had given our original caller a few credit references. These had been looked up during the day, credit O.K.'d and the set delivered without "cash on the barrel-head."

There are a lot of other interesting points about this mythical chain-store repair shop.

Each employee was trained for his particular job. He or she was an expert in whatever work was done. Receptionists, clerks, telephone girls, salesmen-servicemen, etc., all fit into the complete organization.

The trucks, test equipment, furniture, office equipment, etc., were modern in every respect.

Repair costs to the customer were based on actual cost figures plus a reasonable profit. Due to the very large turn-over, the profit on each set was very small.

All means of advertising were used to keep the repair business moving. Newspapers—radio—hand—bills—house-to-house canvassing crews—direct-mail, etc.

Besides this type of repair business, the organization did all authorized service work for most of the large dealers in the city. They paid a small commission for all work received through such outside sources. However, in the case of dealers, to earn the commission the dealer was billed and he in turn billed the customer.

A large warehouse was part of the main repair station. As many types and varieties of parts were kept in stock as in the largest jobber's stock. A perpetual inventory was kept with minimum quantities calling for a re-

order and with an efficient order and follow-up system.

Besides all this, after paying all taxes, wages, bills, insurance, etc., the organization was actually making a profit because they charged fair prices obtained from accurate data and they gave prompt, efficient service.

So—it can't happen here?

I'd hate to bet against it!

—50—

### Ham Chatter

(Continued from page 35)

WSUUV, Pat of Royal Oak, is also hrd. on 160 P. W8TNU, Lou, is now running 340 watts on 160 P. W8NFF is giving 2½ meters a try.

WSUMX, Homer of Centerline, is also hrd quite regularly on 160. W8OGV, George of River Rouge was hrd trying to get on 10.

It is said that the Detroit Street es Railway Bus service saved the city over \$80,000 this year by installing two-way communication between the main street office es the dispatch cars, es firing 41 men. Bah!

W8MYG of Lincoln Park, has a 2½ meter trans-receiver in his buggy. He also has a 20 year old 203A still perking in the big rig, which he got from Doc, W8WO of Ecorse.

W8KKZ, Pete of River Rouge, runs about 300 watts on 10, with an 812 in the final, modulated by a pair of T30's in the push-pull. How about a snaps, Pete?

W8URO really improved his sig 100% after the first day on the air. Steel plays around with 160 P mostly.

W8UWO, Milt, who received his call lately is also hrd. on 160. How about 40 meters, Milt?

W8SYT & SYX are both new hams hr in Burbank, Calif. SYX is ex 7EGM. Both on 160 but Royal, SYT, worked 8 states in 1st 2 months (½ wave ant. hi!)

Suggestion: The old Hallcrafters 5 tube T.R.F. (before 1st Sky Buddy) makes excellent E. C. Osc. witness: W6SLF, yours truly. New tube lineup (42-42-6L6G) but only minor changes in band change sw. wiring and there u are es band switching exciter 20 to 160 meters. No xtal in shack, hi! 160 chief band hr too. Carbon mike bleeder system from power supply works fine.

—50—



## Directional Automatic RADIO CONTROL

Radio homing devices aren't new. They've been in use for years, and are standard equipment on all the air transports. Now **FLYING** and **POPULAR AVIATION** brings you all the facts on a completely new type of radio control—a directional automatic radio control that holds an aircraft on traffic lines without any more help from the pilot than flipping a couple buttons! Read all about this sensationally new control in the

FEBRUARY ISSUE

**FLYING AND POPULAR AVIATION**

Now On Sale At All Newsstands



**As I See It!**  
(Continued from page 14)

between engineering and selling price as it relates to the manufacturing of test equipment.

Naturally we cannot speak officially, but we hazard the statement that if such standards are established, the *NRPDA (National Radio Parts Dealer's Association)* will be interested, for it will clarify the test equipment situation as far as the jobber is concerned. We also feel that the various magazines catering to the radio service field will be interested, for it then will give them a solid foundation upon which to rest their case, as far as advertising of test equipment is concerned.

In all of this there is no attempt to stifle any one organization, for anybody can go into the test equipment business, but let there be some definite conditions which must be met when equipment is offered to the servicing public.

**Location and Knowledge**

SOME time ago we had occasion to speak with the radio service manager of one of the midwestern power utility companies. They sell quite a few radio receivers and consider the service problem to be one of great importance. The more receivers they can keep in proper working order, the greater the income from power sold to the customers. Well, during the conversation a very interesting thing came to light. I don't think that many people think about it, at least not the servicemen who live in cities. It seems, and it does make sense, that the serviceman operating in a rural community runs up against problems somewhat more acute than the city man. In fact, so much so, that one would be tempted to say that the rural serviceman must know more of the tricks of the trade than his metropolitan brother. But this is easier said than done, for how is it possible to set limits upon a man's knowledge? Who can say what Brown in town must know and what Dick in the sticks must know, and where the two divide?

But it is true that Brown in town is seldom, if ever, confronted with the situation that receiving conditions are very poor in the daytime, and then so good at night, that it might just as well be bad, for all the good that it does to the receiver owner and the organization who sold the receiver. Brown in town is called in to repair a defective receiver, but Dick on the other hand must fix a perfectly good receiver so that it will work well—and if you've never done that, brother, you have something to look forward to.

Antennae do not present much of a problem in a large town because almost anything will do. Not that we recommend anything in the form of an antennae, but what's true is true, for some of the locals lay down a powerful signal. But out in the country it's different. An antenna that's long enough for daytime use, pulls in too many signals at night and there is trouble from insufficient selectivity. Receiving conditions are too good, and that happens in too many instances. Cut down the signal pick-up and noise begins to become troublesome. To try to convince the customer that nothing is wrong with the receiver under such

conditions is like driving a nail through the wall with one's bare hand.

Some of the boys out in the sticks have to play some funny tricks with aerials. Many of them are not according to Hoyle; they double back on each other and the pictures have never appeared in any text books, but that's what works best, so that's what is left. And more than once the gain of the receiver must be killed so that satisfactory reception is possible at night, with nothing available in the daytime. Or maybe a trap or two must be arranged to take out some interfering station, that is, if Joe Jones, the owner, is finally convinced that the programs on the interfering station are no good anyway and he should listen to station Blah blah blah. Then again it takes some high talking to convince the receiver owner that the poor reception in the daytime is not due to the receiver design; and in some particularly bad cases, the receiver must be "souped up" to provide that last "nth" of sensitivity for daytime reception and "souped down" to provide normal reception during the night.

Unfortunately such details are not in the service manuals and each man is on his own and believe you me, I've seen some tough jobs cracked by the most unorthodox of unorthodox methods. It would take a radio engineer a year or two to try to conceive some explanation for what was accomplished, but it was a fact . . .

Yes, sir, that serviceman who operates out in the flatlands or up in the mountains has himself a man-made job, or maybe man did not make that job—but he has it just the same. I'll stick to the city. It's much easier on the nerves. And as a last thought, we concur with this service manager who says that the service boy the city feller calls a hayseed must have more tricks up his sleeve than the city slicker.

**What the Traffic Will Bear**

ONE night we gave a talk and said that maybe successful operation of the servicing business means getting what the traffic will bear. Before you jump down my throat, remember that the previous sentence already embraces competition and if satisfaction is given, it also means honest operation, for whoever is satisfied with the work done and the corresponding charge made, has not been overcharged. If he felt he were overcharged, he would not be satisfied with the job.

Well, we have witnessed some perfect examples of the above during the past two weeks, and they tend to confirm our convictions that under certain conditions, considering the workings of the human mind, there is nothing wrong in charging as much as the traffic will bear. Granted, you must pick your spot, but there must be such spots in the life of every man in business who is selling a service and not a commodity that can be labeled as to price. They make up for those cases when the public gets the best of the bargain because of some unfortunate situation, like not being able to find out what's wrong with an intermittent or because some female customer is suffering from unrequited love.

But getting back to the incidents we mentioned before, one serviceman lost a job because his estimate was not enough. We don't wish to describe the whole affair, but we do know that the

**SPRAYBERRY TRAINS YOU**  
for  
**GOOD PAY!**  
**STEADY WORK!**  
**ADVANCEMENT!**  
in  
**RADIO and TELEVISION**



**DON'T WAIT! START NOW!**  
You Can Make Money Almost At Once  
You'll be quickly shown how to get and do neighborhood Radio Service jobs - for practice and profits. You easily learn Television, Frequency Modulation, Signal Tracing, Mobile Radio (Auto-Tanks), Aviation Radio, Electronics, Facsimile Radio, Radio Set Repair and Installation Work. I'll Prepare You Quickly In Spare Time

**At Home Or At Camp**  
SPRAYBERRY Training does not interfere with your present work. You will receive personal coaching service all the way. You'll be fitted to hold down a good paying job in Radio or to have a Radio business of your own.  
**You Get Professional Test Equipment**  
... Plus Experimental Outfits  
Includes 148 RADIO PARTS (to build complete Radio Receiver), RADIO TOOLS and a TESTER-ANALYZER. MY EXPERIMENTAL OUTFITS enable you to conduct actual experiments with your own hands.

**NO EXPERIENCE NEEDED**  
It makes no difference what your education has been. I can fit you to become a real RADIO TECHNICIAN. Your success is my full responsibility.

**THE SPRAYBERRY COURSE IS SOLD UNDER MONEY-BACK AGREEMENT**

**RUSH COUPON for BIG FREE BOOK**

**SPRAYBERRY ACADEMY OF RADIO**  
F. L. Sprayberry, President  
425-B University Place, N. W.  
Washington, D. C.

Please rush my **FREE** copy of "HOW TO MAKE MONEY IN RADIO."

Name..... Age.....  
Address.....  
City..... State.....  
(Mail in envelope or paste coupon on penny postcard)

**FREE! NEW 1941 PROFIT GUIDE**  
*Everything in RADIO!*

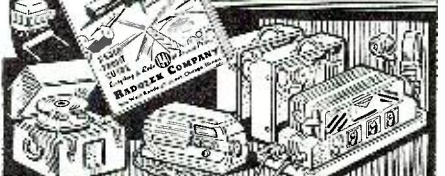

**Complete Selections... Guaranteed Quality**

**Replacement Parts**  
Everything you need in exact duplicate or universal replacement or repair parts. Tubes, condensers, resistors, transformers, hardware, tools, etc. Leading brands.

**Latest Radio Sets**  
A model for every purse and purpose. Auto Sets, Midgets, Battery Portables, Table Models, Consoles, Phono-Radio and recorder combinations—for operation on AC or DC.

**Public Address Equipment**  
A complete line of amplifiers, microphones, baffles, recording equipment and accessories for every type of installation—permanent, portable and mobile, from 5 to 100 watts.

**Newest Electric Appliances**  
Extra profits for you! Standard Brand Electric Irons, Grills, Toasters, Percolators, Waftie Irons, Vacuum Cleaners, Clocks, Mixers and many others, all at lowest prices.

**YOU SAVE MONEY AT RADOLEK**

**MAIL THIS COUPON TODAY**

**The RADOLEK CO.**  
601 W. Randolph St., Chicago, Dept. B-50  
Send the New 1941 Radio Profit Guide **FREE**.  
Name.....  
Address..... Dealer?.....  
Experimenter?..... Serviceman?..... Amateur?.....

# Wet ELECTROLYTICS



**Type PG600**—Max. 600 v. D.C. Surge; 1 3/8" and 1 1/2" dia. can. 3 3/4" to 4 1/2" high, 4 to 16 mfd., \$1.35 to \$2.00 list.

**Type PG500**—Max. 500 v. D.C. Surge; 1 3/8" and 1 1/2" dia. can. 3 3/4" to 4 1/2" high, 4 to 40 mfd., \$0.80 to \$1.90 list.

**Type PG350**—Max. 350 v. D.C. Surge; 1 3/8" and 1 1/2" dia. can. 3 3/4" to 4" high, 8 to 40 mfd., \$0.90 to \$1.80 list.

**Type PGM500**—Max. 500 v. D.C. Surge; 1" dia. can. 3 1/2" to 4 1/2" high, 4 to 16 mfd., \$0.80 to \$1.35 list.

**Type PGM350**—Max. 350 v. D.C. Surge; 1" dia. can. 3 1/2" and 4 1/2" high, 8 to 20 mfd., \$0.90 to \$1.40 list.

**Type PGM250**—Max. 250 v. D.C. Surge; 1" dia. can. 3 1/2" and 4 1/2" high, 8 to 40 mfd., \$0.80 to \$1.20 list.

**Type PGM150**—Max. 150 v. D.C. Surge; 1" dia. can. 3 1/2" and 4 1/2" high, 8 to 40 mfd., \$0.70 to \$1.15 list.

- High capacity in minimum bulk; ability to take severe punishment; instant self-healing or reforming of dielectric film following break-down due to excessive voltages—these factors account for the growing popularity of wet electrolytics. ● Meanwhile, the elimination of such drawbacks as leakage and seepage, and inadequate venting, heretofore associated with this type, accounts for Aerovox "wets" as the first choice. ● A trial will soon convince you.

## ● Ask Your Jobber . . .

Ask for these Aerovox "wets." Try them in that "rig" you are building. Particularly for filter circuits where you anticipate violent surges. Ask for latest catalog. Or write us direct.



trouble was trivial and the first man was honest to the bone and said that the whole job would cost \$5.00. The owner did not like that very much because the installation cost about \$5000. The other serviceman asked \$64.00 and got the job. Don't ask me how he arrived at \$64.00. Maybe he played that number that day or perhaps it was two times his wife's age, but the fact remains that the customer felt that no defect in a \$5000 sound installation in his home could be so trivial as to cost only \$5.00 to repair yet give him all of the aggravation that it did.

Then we know of another case. This involves the sale of service. Unfortunately as much as we would like to mention the actual case, we cannot do so because the man who paid the bill might have occasion to read this paper and far be it from us even to remotely suggest that he paid a few dollars too much, particularly when we know that his investment in this instance is of the human variety, for which there is not supposed to be any price. To sum it up, one purveyor in service, and we beg forgiveness for speaking about a disciple of Hippocrates in such terms, received a century note per visit for work which normally would call for just a small fraction of this sum, but he could not charge less, for the recipient of the service considered the case of such merit, personal opinion of course, as wholly to justify the charge. From our viewpoint we agree with the medico, for satisfaction was rendered and when looked at from the economical angle, simply compensated for those numerous instances when services were rendered at a financial sacrifice.

So we reiterate the substance of the talk. If and when the opportunity arises, and providing that satisfaction is given, the proper service charge is *what the traffic will bear.*

### A Few Thoughts at Random

VARIOUS services outside of the commercial radio broadcast field are working at frequencies which range from 100 megacycles to as high as 1500 megacycles. Maybe ten or fifteen years will pass before we see such things in the general broadcast field but that which is high to us today in the multi-waveband receivers will be low in time to come. 1500 megacycles is 20 centimeters and 20 centimeters is 7.9 inches! That doesn't look so small at that.

### Manufacturers' Literature

(Continued from page 40)

Interested persons upon request. Free. (RADIO NEWS No. 2-104.)

### Use this coupon for catalogs

RADIO NEWS, Catalog Dept.  
603 S. Dearborn Street, Chicago, Ill.

Please send me the literature I have checked below. If there is any charge I have enclosed the money

..2-100 ..2-101 ..2-102 ..2-103  
..2-104

Name .....

P. O. Address .....

Printed in U. S. A.

# SERVICEMAN'S CASE HISTORIES

Reprinted with permission, from **RADIO Trouble Shooters Handbook**. Copyright, 1939, Radio & Technical Publishing Co. Copyright in Canada and Great Britain, and all countries subscribing to the Berne Convention, by Radio & Technical Publishing Co. All rights reserved.

**GENERAL ELECTRIC (CANADIAN) H-71**  
(Uses same chassis as RCA Radiola 86 receiver.)  
See the Case Histories listed for the RCA Radiola 86 receiver

**GENERAL ELECTRIC (CANADIAN) H-72**  
(Uses same chassis as RCA RAE-59 receiver.)  
See the Case Histories listed for the RCA RAE-59 receiver

**GENERAL ELECTRIC (CANADIAN) H-77**  
(Uses same chassis as RCA R-7A and RE-16 receivers.) See the Case Histories listed for the RCA R-7A and RE-16 receivers

**GENERAL ELECTRIC (CANADIAN) J-82**  
(Uses same chassis as RCA R-71 receiver.) See the Case Histories listed for the RCA R-71 receiver

**GENERAL ELECTRIC (CANADIAN) J-85**  
(Uses same chassis as RCA R-10 and R-12 receivers.) See the Case Histories listed for the RCA R-10 and R-12 receivers

**GENERAL ELECTRIC (CANADIAN) J-86**  
(Uses same chassis as RCA R-72 receiver.) See the Case Histories listed for the RCA R-72 receiver

**GENERAL ELECTRIC (CANADIAN) J-105, J-107**  
(Use same chassis as RCA R-74, R-76 and R-77 receivers.) See the Case Histories listed for the RCA R-74, R-76 and R-77 receivers

**GENERAL ELECTRIC (CANADIAN) J-125**  
(Uses same chassis as RCA R-73 receiver.) See the Case Histories listed for the RCA R-73 receiver

**GENERAL ELECTRIC (CANADIAN) K-50**  
(Uses same chassis as RCA R-23 receiver.) See the Case Histories listed for the RCA R-23 receiver

**GENERAL ELECTRIC (CANADIAN) K-52, K-53**  
(Use same chassis as RCA R-28-P, RCA-110, RCA-111 and RCA-115 receivers.) See the Case Histories listed for the RCA R-28-P, RCA-110, RCA-111 and RCA-115 receivers

**GENERAL ELECTRIC (CANADIAN) K-57**  
(Uses same chassis as RCA-120 receiver.) See the Case Histories listed for the RCA-120 receiver

**GENERAL ELECTRIC (CANADIAN) K-59**  
(Uses same chassis as RCA-110, RCA-111 and RCA-115 receivers.) See the Case Histories listed for the RCA-110, RCA-111 and RCA-115 receivers

**GENERAL ELECTRIC (CANADIAN) K-60**  
(Uses same chassis as RCA R-37 receiver.) See the Case Histories listed for the RCA R-37 receiver

**GENERAL ELECTRIC (CANADIAN) K-62**  
(Uses same chassis as RCA R-11 receiver.) See the Case Histories listed for the RCA R-11 receiver

**GENERAL ELECTRIC (CANADIAN) K-64**  
(Uses same chassis as RCA-121 receiver.) See the Case Histories listed for the RCA-121 receiver

**GENERAL ELECTRIC (CANADIAN) K-79**  
(Uses same chassis as RCA-331 receiver.) See the Case Histories listed for the RCA-331 receiver

**GENERAL ELECTRIC (CANADIAN) K-80, K-85**  
(Use the same chassis as RCA-140 and RCA-140-E receivers. See the Case Histories listed for the RCA-140 and RCA-140-E receivers)

**GENERAL ELECTRIC (CANADIAN) K-106**  
(Uses same chassis as RCA R-90 receiver.) See the Case Histories listed for the RCA R-90 receiver

**GENERAL ELECTRIC (CANADIAN) K-126**  
(Uses same chassis as RCA-280 receiver.) See the Case Histories listed for the RCA-280 receiver

# "The More You Learn - The More You Will Earn"

LEARN QUICKLY... ALL YOU NEED... AT LOW COST  
IN GHIRARDI'S 3 FAMOUS RADIO BOOKS

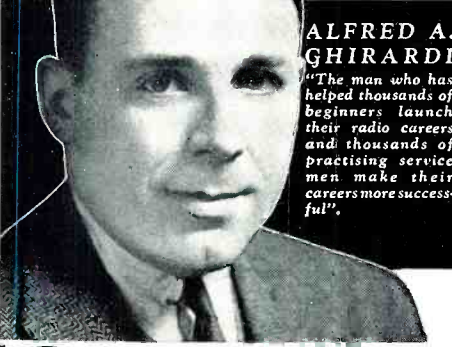

**ALFRED A. GHIRARDI**  
"The man who has helped thousands of beginners launch their radio careers and thousands of practicing service men make their careers more successful".

## Service Men: You Need Both JOB DATA and THEORY!

### RADIO Trouble-Shooter's HANDBOOK

Regardless of what radio set you are called upon to repair, this new "Ghirardi" Handbook is guaranteed to save you Time, Chock full of factory-checked "bench data" that will speed up every service job you do. That means More Money for you!

**3,313 CASE HISTORIES to Save Your Servicing Time!**

This section alone is worth many times the nominal price of the book. Here at a glance is dependable factory-checked "Case History" repair data on 3,313 different receivers! Compiled from actual service records—with precise instructions on where to look for troubles and how to remedy them. Just think of the time these will save you! But that's not all—see what else you get:

**518 BIG 8 1/2 x 11 PAGES—134 ILLUSTRATIONS, DRAWINGS, CHARTS, TABLES—GIVE VITAL INFORMATION ON:**

Time-Saving Trouble Case Histories for 3,313 receivers—**I-F Peaks for 15,000 Superhets—Trouble-Shooting Charts—Auto Radio Gear Ratios—Auto Radio Installation, Servicing, Interference Suppression Charts—Servicing Sound Recorders and Intercommunicators—Condenser & Resistor Charts—Grid Bias Resistors—Color Codes—Wire Tables—Coils—Transformers—Formulas—Calculations—Decibel Charts—Tube Charts—Dial Lamps—Ballast Resistors—Filters—Trade Directories—and dozens of other detailed subjects.**

The only book of its kind! Contains the greatest mass of practical working service data ever assembled in one book. A servicing gold mine! Used daily by thousands of service shops. Order yours now—Money back if not satisfied.

**\$3**

518 PAGES, 134 Illustrations, Standard Manual Size (8 1/2 x 11). Fabricoid bound.

**MONEY-SAVING "COMBINATION PRICE"**

**1300 PAGES, 706 Illustrations, 720 Review Questions, 766 Topics. \$4**

### MODERN Radio SERVICING

This great servicing book gives you a complete, concise, self-instruction course in present-day servicing methods as practiced by leading servicing organizations throughout the country. You get a complete course in basic servicing theory, together with the practical applications—essential knowledge for trouble-shooting and repairing the complicated receivers of today. This great book is the only one in the world that teaches you everything you need to know right in your own home—easily, in your spare time, and inexpensively!

#### LEARN SERVICING This Way!

- **Test Equipment**—First, a thorough 420-page course in Test Instruments—Theory, Descriptions, Diagrams of all Commercial Instruments. How They Work, Construction Data, etc.
- **Trouble-Shooting**—Next, all newest short-cut factory methods for Trouble-shooting and Testing all makes of radio sets (and electronic equipment)—explained clearly and step-by-step.
- **Repairing**—Then how to Align and Adjust receivers; how to Repair or Replace faulty parts. "Factory" methods explained fully.
- **Business Promotion**—Finally, how to Manage, Promote and Advertise a radio service shop for greatest profits.

MODERN RADIO SERVICING brings you an illustrated treasure chest of servicing knowledge—all based on practical servicing experience! 720 Self-Examination Review Questions check every step of your progress. Order yours now—costs you only \$4 to learn radio service work this EASY way! Money back if not satisfied!

## Beginners—Here's YOUR EDUCATION in RADIO Fundamentals

NOW—at last—you can get your start in Radio... you can prepare for a good-paying radio job, without expensive schooling or lengthy study. Here in one inexpensive volume is a complete Radio Education for you—everything clearly explained, illustrated and easy to understand—right from basic electrical theory up through Television, Cathode-Ray tubes, Aircraft Radio, Public Address, Photoelectric Cells, etc.

### The Complete Ghirardi Course in 1 Handy Volume

Radio Physics Course is a miracle of condensation. It's really 36 different instruction courses covering the vast field of Radio all packed into 1 big easy-reading, home training book—everything you need for a complete knowledge of modern Radio Fundamentals!

#### 36 VOLUMES IN 1

1. Radio Broadcasting System.
2. Sound, Speech, Music.
3. Electron Theory, Electric Current.
4. Electrical Units, Ohm's Law, Resistance.
5. Electrical Circuits, Batteries.
6. Magnetism.
7. Electro-magnetism.
8. Electromagnetic Induction.
9. Inductance.
10. Capacitance, Condensers.
11. Alternating Current Circuits.
12. Electric Filters.
13. Measuring Instruments.
14. Radio Waves.
15. Broadcasting.
16. Receiving.
17. Vacuum Tube Principles.
18. Vacuum Tube Characteristics.
19. Vacuum Tube Construction.
20. Vacuum Tube Detector and Amplifier Action.
21. Radio Frequency Amplifiers.
22. Superheterodyne Receivers.
23. Power Supply Units.
24. Audio Amplifiers.
25. Speakers.
26. Battery Operated Receivers.
27. Aircraft Radio.
28. Electric Receivers.
29. Automobile and Short-Wave Reception.
30. Photoelectric Cells, Cathode-Ray Tubes.
31. Television.
32. Antennas and Grounds.
33. Testing, Servicing.
34. Sound Motion Pictures.
35. Appendix of Charts and Tables.

### YOU LEARN AT HOME Quickly—EASY AS A.B.C.

Sit in your easy chair and let Ghirardi train you for whatever type of radio work you want to do. It's as simple as that! Just spend a few minutes a day of your spare time reading this fascinating book. No previous study or experience necessary—no "math"! You teach yourself, checking your progress with the 856 self-testing Review Questions. Never before has it been possible to master the Basic Fundamentals of Radio so easily, so quickly, so economically.

### TELEVISION MADE EASY, TOO!

The Television section is a whole course in itself! And as for Sound Engineering, you get up-to-date instruction in Public Address Systems, Sound Recording, Phonograph Pickups, Sound Motion Pictures, etc., etc. It's the same with Photoelectric Cells and Cathode-Ray Tubes—each of these specialized services a career in itself. Now, everything you want—all right here! The U. S. Army also uses this very same book for their radio training courses. Civil aviation schools and leading radio schools everywhere use it more than any other radio text published. Ghirardi's course is **TOP!** Send for your 5-Day Examination copy TODAY! Rush the coupon to us at once!

**Only \$4**  
972 PAGES  
508 ILLUS

**GET STARTED DO IT NOW!**



### Here's how to get your books:

Radio & Technical Publishing Co., Dept. RN-21, 45 Astor Place, New York, N. Y.

- Gentlemen: Enclosed find payment for and rush to me postpaid for Examination, with 5-Day Money-Back Guarantee:
- MODERN RADIO SERVICING at \$4.
  - RADIO TROUBLE-SHOOTER'S HANDBOOK at \$3. (foreign \$3.50)
  - BOTH SERVICING BOOKS at \$6.50 Special Money-Saving Combination Price (foreign \$7)
  - RADIO PHYSICS COURSE at \$4. (foreign \$4.50)

NAME .....  
ADDRESS .....  
CITY ..... STATE .....  
 Please send me FREE descriptive illustrated literature.

TEAR OFF COUPON, MAIL IN ENVELOPE, OR PASTE ON A POSTCARD

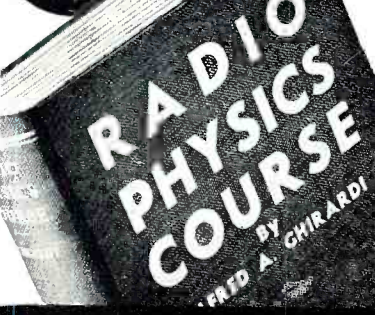

**Use Them 5 DAYS - OUR RISK Money-Back Guarantee!**

# A NEW RECTIFIER WITH A **LONGER LIFE!**

**RCA**  
**866-A/866**

**HALF-WAVE  
MERCURY-VAPOR  
RECTIFIER**

**\$150**

**Amateur Net**



RCA engineering scores again! Not only does the new RCA-866-A/866 half-wave, mercury-vapor rectifier handle higher voltage at lower initial cost, but its truly great life means even greater value for your money. Once installed in your rig you can forget rectifier tube problems for a long, long time to come.

This new tube supersedes the 866 and 866-A and may be used in equipment designed for these types. An exclusive RCA development, it combines the ability of the 866 to conduct at relatively low plate voltage with that of the 866-A to withstand a high peak inverse voltage—and, in addition, gives you a *plus* performance that makes it far and away the greatest rectifier value RCA has ever offered.

Secret of the 866-A/866 is another top notch RCA engineering achievement—an edgewise-wound coated ribbon filament, illustrated at right, of great mechanical strength and providing more cathode area for the same filament power rating. This filament utilizes a new alloy material that not only has tremendous electron-emitting capabilities, but also holds the key to greater life.

Important among other features of the tube is the special filament shield which makes practical the use of a very low starting voltage. A ceramic cap insulator and new dome-top bulb minimize danger from bulb cracks caused by corona discharge and resultant electrolysis.

Get more for your money! Make sure your new rectifiers are RCA-866-A/866's.



*Unique New  
Filament  
Design Used in  
the 866-A/866*

#### **RATINGS**

Filament Voltage (A-C) . . . . .	2.5 volts
Filament Current . . . . .	5.0 amperes
Peak Inverse Voltage . . . . .	10,000 max. volts
Up to 150 cycles per second . . . . .	5,000 max. volts
Up to 1,000 cycles per second . . . . .	1,0 max. ampere
Peak Plate Current . . . . .	0.25 max. ampere
Average Plate Current . . . . .	15 volts
Tube Voltage Drop (approx.) . . . . .	

## **SENSATIONAL PERFORMANCE**

**... at a New Low Price!**

- **LONGER LIFE**—Assured by radically improved new filament, dome bulb and insulated plate cap.
- **HIGH RATING**—10,000 volts, peak inverse voltage. 1000 ma., peak plate current.
- **ENORMOUS EMISSION RESERVE**—Provides ability to withstand high peak loads.



## **Transmitting Tubes**

**PROVED IN COMMUNICATION'S MOST EXACTING SERVICES**

**RCA MANUFACTURING CO., INC., CAMDEN, N. J. • A Service of The Radio Corporation of America**

*In Canada: RCA VICTOR COMPANY LIMITED, MONTREAL*